



DOWNTOWN BERKELEY

DESIGN GUIDELINES

CITY OF BERKELEY | 2012

CONTENTS

INTRODUCTION	7	SIGNS & GRAPHICS	49
Purpose	9	All Signs	51
Objectives of the Downtown Area Plan	9	Wall Signs	53
PROCEDURES	11	Projecting Signs	53
Projects Subject to these Guidelines	13	Window Signs	53
How to Use this Document	14	Awning, Canopy or Marquee Signs	54
How this Document will be used to		Murals	54
Review Projects	16	Sign Banners	54
Comments & Suggestions	16	Sings on Taller Buildings	54
Review Procedures	17	SITE DESIGN	55
<i>Map of Landmark & Significant Buildings</i>	18	FRONTAGES, SETBACKS & HEIGHTS	57
HISTORICAL OVERVIEW	19	<i>Map of Public-Serving Frontage</i>	61
Period of Significance	21	HEIGHTS	63
Transportation Framework	22	OPEN SPACES	65
20th Century Development	22	PARKING & LOADING	68
University of California	23	SPECIAL SITES, BUILDINGS & SUBAREAS	69
Downtown Today	23	Corner Sites	71
BUILDING DESIGN	25	Important Vistas	71
FACADES	27	Civic Buildings	72
ROOF FORMS	33	Parking Structures	73
STOREFRONTS & ENTRANCES	35	Parking Lots	75
MATERIALS	39	SUBAREAS WHERE HISTORIC RESOURCES	
DETAILS & ORNAMENT	41	ARE CONCENTRATED	75
COLOR	42	SPECIAL CONSIDERATIONS	77
LIGHTING, SECURITY & EQUIPMENT	43	Code Considerations	79
SPECIAL HISTORIC FEATURES	44	Seismic Considerations	79
AWNINGS & CANOPIES	45	Accessibility	80
General	47	Funding	80
Awnings	47	Sustainability	81
Canopies	48	Street & Open Space Improvements	81
Marquees	48		-

Acknowledgements

1993 Downtown Design Guidelines

Jeffrey S. Leiter, Mayor
Loni Hancock, Former Mayor
Members of the City Council

Gil Kelley, Planning Director

Patricia McGowan, Project Manager

H Ruth Todd AIA, Main Street Consultant
ELS Architects, Consultant
Donn Logan, FAIA
Kerry O'Banion, AICP
Richard Wagner AIA, Main Street Consultant

Downtown Berkeley Association
Berkeley Main Street
Design Committee
Berkeley Architectural Heritage Association
Planning Commission
Landmarks Preservation Commission
Design Review Committee
Berkeley Design Advocates

Numerous local citizens, architects, property owners, and business people

2011/2012 Amendments

Tom Bates, Mayor
Members of the City Council
Phil Kamlarz, City Manager/
Christine Daniel, Interim City Manager
Dan Marks, Planning Director/
Wendy Cosin, Interim Planning Director
Matt Taecker, Principal Planner & Designer/
Alexander Amoroso, Principal Planner

Members of the Planning Commission
Landmarks Preservation Commission
Design Review Committee
Downtown Area Interns

INTRODUCTION

- PURPOSE
- OBJECTIVES OF THE
DOWNTOWN AREA PLAN

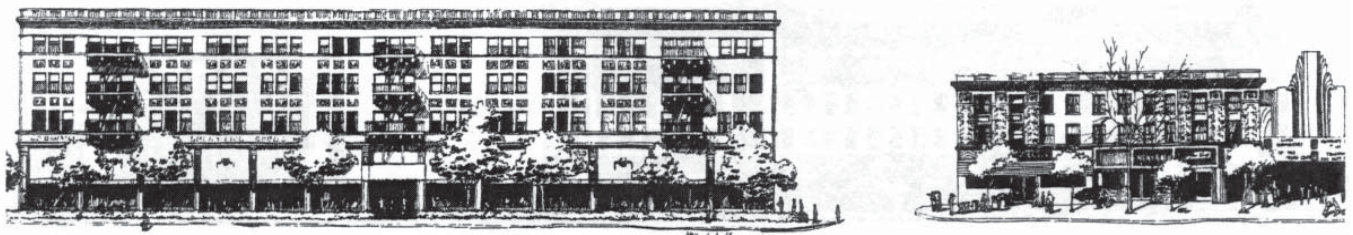

Figure 1: Downtown Berkeley (Artist: Yeo Hock Wah; Source: Berkeley Architectural Heritage)

INTRODUCTION

PURPOSE

These design guidelines implement the objectives and policies of the Historic Preservation and Urban Design chapter of the Berkeley Downtown Area Plan. The Downtown Area Plan establishes policies to guide future physical development in the Downtown Area, and sets as a priority the preservation of historic buildings, while promoting new development that complements Downtown's traditional and human-scaled character. New development should also address today's needs, and these Guidelines are not intended to discourage contemporary architectural expressions so long as they are appropriately sensitive to their context.

This document provides specific guidance on how to modify existing buildings and construct new ones in a manner which furthers the goals and objectives of the Downtown Area Plan. It also describes the sequence of City reviews and approvals leading to a building permit, as well as code and other considerations which may affect certain types of projects.

This document is written for property owners, building tenants, architects, designers, developers, city staff, and members of City boards and commissions who influence physical change in Downtown. It is meant as a guide to ensure that future changes will protect, enhance, and be compatible with the historic character of Downtown Berkeley.

While the Downtown Area includes some residential-only blocks, the focus of these Guidelines – and the principal focus of the Downtown Area Plan – are areas where a mix of uses can be developed, including commercial, cultural, and residential uses.

OBJECTIVES OF THE DOWNTOWN AREA PLAN

The Berkeley Downtown Area Plan establishes four goals for Historic Preservation and Urban Design:

- Goal HD-1: Conserve Downtown's historic resources, unique character, and sense of place.*
- Goal HD-2: Enhance areas of special character in Downtown, such as clusters of historic resources.*
- Goal HD-3: Provide continuity and harmony between the old and the new in the built environment.*
- Goal HD-4: Improve the visual and environmental quality of Downtown, with an emphasis on pedestrian environments that are active, safe, and visually engaging. Encourage appropriate new development Downtown.*

These goals, and their respective policies, have already been incorporated in the design of several successful development projects in the Downtown Area. Recent investments in historic rehabilitation, renovation, and suitably scaled new construction demonstrate that the multiple goals of economic viability, historic preservation, and sensitive urban design are complementary, and that good design is good for business.

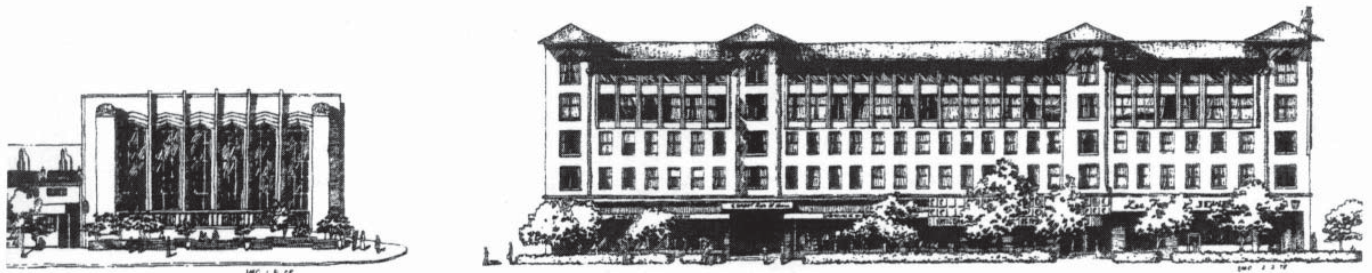

PROCEDURES

- PROJECTS SUBJECT TO THESE GUIDELINES
- HOW TO USE THIS DOCUMENT
- HOW THIS DOCUMENT WILL BE USED TO REVIEW PROJECTS
- COMMENTS & SUGGESTIONS
- REVIEW PROCEDURES

PROCEDURES

PROJECTS SUBJECT TO GUIDELINES

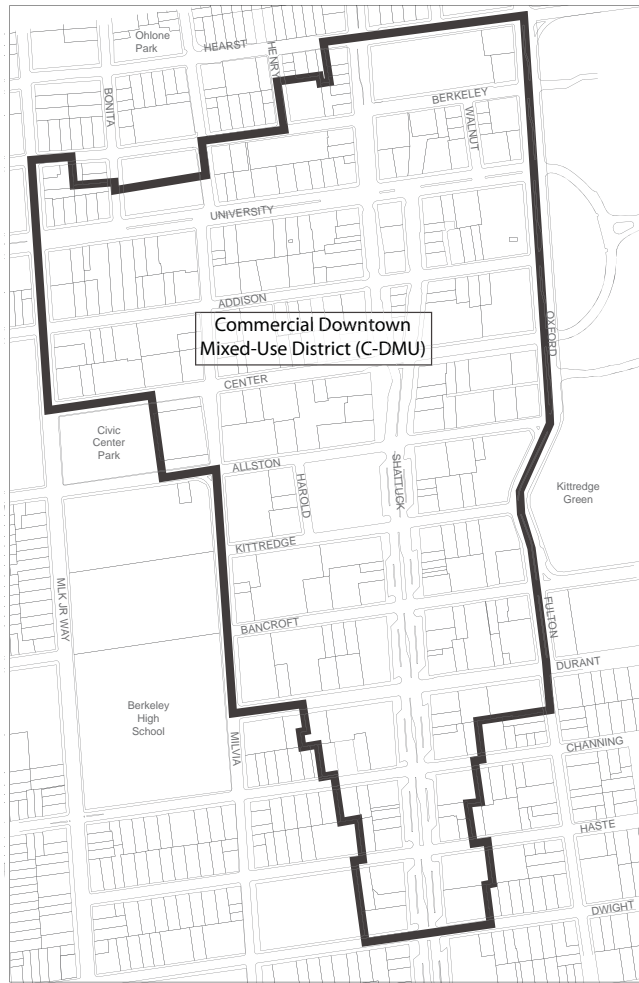

Figure 2: Commercial Downtown Mixed-Use (C-DMU) District Area. These Guidelines apply to parcels where mixed-use development is permitted. See Zoning Code for updates.

These design guidelines apply to parcels and projects located within the Commercial Downtown Mixed-Use (C-DMU). District as defined by Berkeley’s Zoning Ordinance and illustrated by Figure 2. Projects subject to these guidelines include all new construction projects; renovations and historic restorations; and façade changes such as storefront remodels, signs, and awnings. Sites and buildings owned by public institutions are also subject to these guidelines.

Within most sections of this document, there are 3-categories of guide lines: those which apply to Landmark Buildings, to Significant Buildings, and to All Buildings. Design guidelines for Landmark Buildings acknowledge that these structures are Downtown’s most precious historic resources, and encourage an historically accurate restoration. The guidelines for Significant Buildings are somewhat more flexible in terms of materials and details; however, the architectural character of Significant Buildings must be preserved.

A map of Landmark and Significant Buildings is included in this document (see Figure 5). This map summarizes the status of parcels throughout the Downtown Area as of March 2009. It indicates the following classes of individual properties:

- “Designated Landmark or Structure of Merit.” This includes properties designated as of March 2009.
- “Significant per BOTH 1993 LPC List and 1994 Design Guidelines.” These are properties (other than those that have been designated as Landmarks or Structures of Merit) that were included in the 1993



Figure 3: Downtown Berkeley (Artist: Yeo Hock Wah; Source: Berkeley Architectural Heritage)

PROCEDURES (CONTINUED)

LPC list of significant buildings as well as in the 1994 Design Guidelines' list of significant buildings.

- "Building on the SHRI." This consists of buildings (other than those in the map's above two categories) that were recorded by the State Historic Resources Inventory of 1977-1979.
- "Other Building Called Contributing or Significant by BAHA Report, 1990 Downtown Plan, LPC List, and/or Design Guidelines." Many of these are buildings were identified as "contributing" by the 1990 Downtown Plan.
- "Development Opportunity Site Apparently Containing No Historic Resource." The mapping of these sites is tentative and illustrative. Nearly all of them involve one-story buildings, parking lots or other open uses, or vacant land. A few properties with two-or-more-story buildings are shown in special cases, including some buildings that are very near the BART station or that have serious seismic problems.

The map also depicts the boundaries of the Civic Center Historic District and the Berkeley High School Historic District.

The guidelines for All Buildings apply to new construction projects and all existing buildings, which are not on the Landmark and Significant Building Lists. Note that additional properties may be documented and designated as historic. On the other hand, some properties that are noted as "Contributing" and "Significant" by the 1987 BAHA report and/or 1990 Downtown Plan may—upon further analysis—be deemed to be not historic. While these design guidelines stress the retention and enhancement of the historic character of Downtown, new design ideas or departures from the guidelines may be considered so long as the design contributes to the overall image and historic context of Downtown Berkeley.

HOW TO USE THIS DOCUMENT

This document is organized so that many chapters and sections are interrelated. All users should read the Introduction, Procedures, and Historical Overview chapters in order to understand the context within which this document is written. To determine other applicable chapters, sections, and guidelines, follow the steps outlined below.

Step One: Determine your project type.

Nine project types are identified in the chart on page 15. Determine your project type and refer to the Guidelines Sections identified in the chart.

Step Two: Determine your building type.

To determine if your project affects a historic resource or potential historic resource, check the map on page 18, and the List of Landmark and Significant Buildings. Always check with the Secretary to the Landmarks Preservation Commission before assuming that a building is not a Landmark or Significant Building as new historic designations may occur.

Within most sections of this document, there are guidelines for All Buildings, Significant Buildings, and Landmark Buildings. These three subdivisions are arranged hierarchically; in case of contradictions, the design guidelines for All Buildings are superseded by Significant Buildings, which are superseded by Landmark Buildings. The checklist below will help you to determine which guidelines to reference for your project.

___ Landmark Building	use guidelines for Landmark Buildings
___ Significant Building	use guidelines for Significant Buildings
___ Contributing Building	analysis & LPC review required to determine building type
___ New Construction	use guidelines for All Buildings
___ all other buildings	use guidelines for All Buildings

PROCEDURES (CONTINUED)

Table 1: Project Types

PROJECT TYPES	<i>Construct New Building</i>	<i>Remodel or Modify Storefront</i>	<i>Remodel Upper Floors</i>	<i>Restore Historic Building</i>	<i>Restore or Modify Storefront on Historic Building</i>	<i>Install or Change Sign</i>	<i>Install or Change Awning</i>	<i>New Parking Structure</i>	<i>New Parking Lot</i>
GUIDELINES									
INTRODUCTION	•	•	•	•	•	•	•	•	•
PROCEDURES	•	•	•	•	•	•	•	•	•
HISTORICAL OVERVIEW	•	•	•	•	•	•	•	•	•
BUILDING DESIGN									
Facades	•	•	•	•	•	•	•	•	
Roof Forms	•		•	•				•	
Storefronts & Entrances	•	•	•	•	•	•	•	•	
Materials	•	•	•	•	•			•	
Details & Ornament	•	•	•	•	•	•	•	•	
Color	•	•	•	•	•	•	•	•	
Lighting, Security & Equipment	•	•	•	•	•			•	•
Special Historic Features	•	•	•	•	•				
AWNINGS & CANOPIES	•	•		•	•		•	•	
SIGNS & GRAPHICS	•	•		•	•	•		•	•
SITE DESIGN	•	•						•	•
SPECIAL SITES, BUILDINGS & SUBAREAS	•	•	•	•	•			•	•
SPECIAL CONSIDERATIONS	•	•	•	•	•	•	•	•	•
APPENDIX	•	•	•	•	•	•	•	•	•

PROCEDURES (CONTINUED)

Step Three: Determine your building or site location. Use the map on page 18.

If it is

- ___ on University Avenue
- ___ on Shattuck Avenue
- ___ at an Oxford Street intersection
- ___ at a street corner
- ___ in the Civic Center area
- ___ along or part of an important visa
- ___ a Civic Building in the downtown area
- ___ a parking lot or structure
- ___ a Green Pathway project adjacent to a property that is an historic resource or has been designated as a City landmark or structure of significance then you must also abide by guidelines in the Special Sites & Buildings chapter, and portions of the Site Design chapter, in addition to those of other chapters. The Special Sites & Buildings guidelines supersede all others, except for guidelines for Landmark Buildings.

HOW THIS DOCUMENT WILL BE USED TO REVIEW PROJECTS

When used in early phases of project design, these guidelines provide essential direction and will help expedite the development review process. Projects will be reviewed for conformance with these guidelines by City staff and review boards and commissions prior to application for a building permit. As every project and circumstances is unique, each project will be reviewed on a case by case basis. Projects which do not strictly follow the guidelines may require justification for non-compliance and/or conditions of approval.

COMMENTS & SUGGESTIONS

In order to ensure that the guidelines in this document accomplish the objectives of the Downtown Plan, they will be reviewed on a periodic basis. Comments and suggestions for revisions are welcome, and should be made in written form to:

Secretary to the Design Review Committee
City of Berkeley, Department of
Planning and Development
2120 Milvia Street
Berkeley, CA 94704



Figure 4: Downtown Berkeley (Artist: Yeo Hock Wah; Source: Berkeley Architectural Heritage)

PROCEDURES (CONTINUED)

REVIEW PROCEDURES

Review procedures may be summarized as follows:

- 1 *Read these guidelines thoroughly.*
- 2 *Obtain information and submittal requirements on line at the Zoning counter. Schedule a pre-application meeting to address issues and guidelines specific to your project if you still have questions. This meeting may be scheduled by calling the Design Review Planner at 981-7410.*
- 3 *For further assistance, call Land Use Planning at 981-7410. The Downtown Berkeley Association, the Berkeley Historical Society, and the Berkeley Architectural Heritage Association may be able to provide additional information and/or input concerning your project and its site. Call Land Use Planning for contact information if needed,*
- 4 *Submitting an application for Design Review or, for a Landmark, a Structural Alteration Permit, initiates the design review process. (Find the Planning & Development Department page at www.cityofberkeley.info for information on obtaining Planning Approval.)*
- 5 *Submit appropriate materials for review. Submittal requirements can be found on website listed above. Depending upon the scope of the project and its building type, approval must be obtained from the Zoning Adjustments Board, City staff, the Design Review Committee, and/or the Landmarks Preservation Commission.*
- 6 *Once the design of your project is approved, a Notice of Decisions will be issued.*
- 7 *File for a building permit in the Permit Service Center. No work may begin until the building permit is issued.*
- 8 *Your proposed project will be reviewed for conformance with applicable building codes and regulations. (See www.cityofberkeley.info for a comprehensive listing of codes.)*
- 9 *Once a building permit is issued, construction on your project may begin.*

Figure 5: Landmarks & Significant Buildings Map

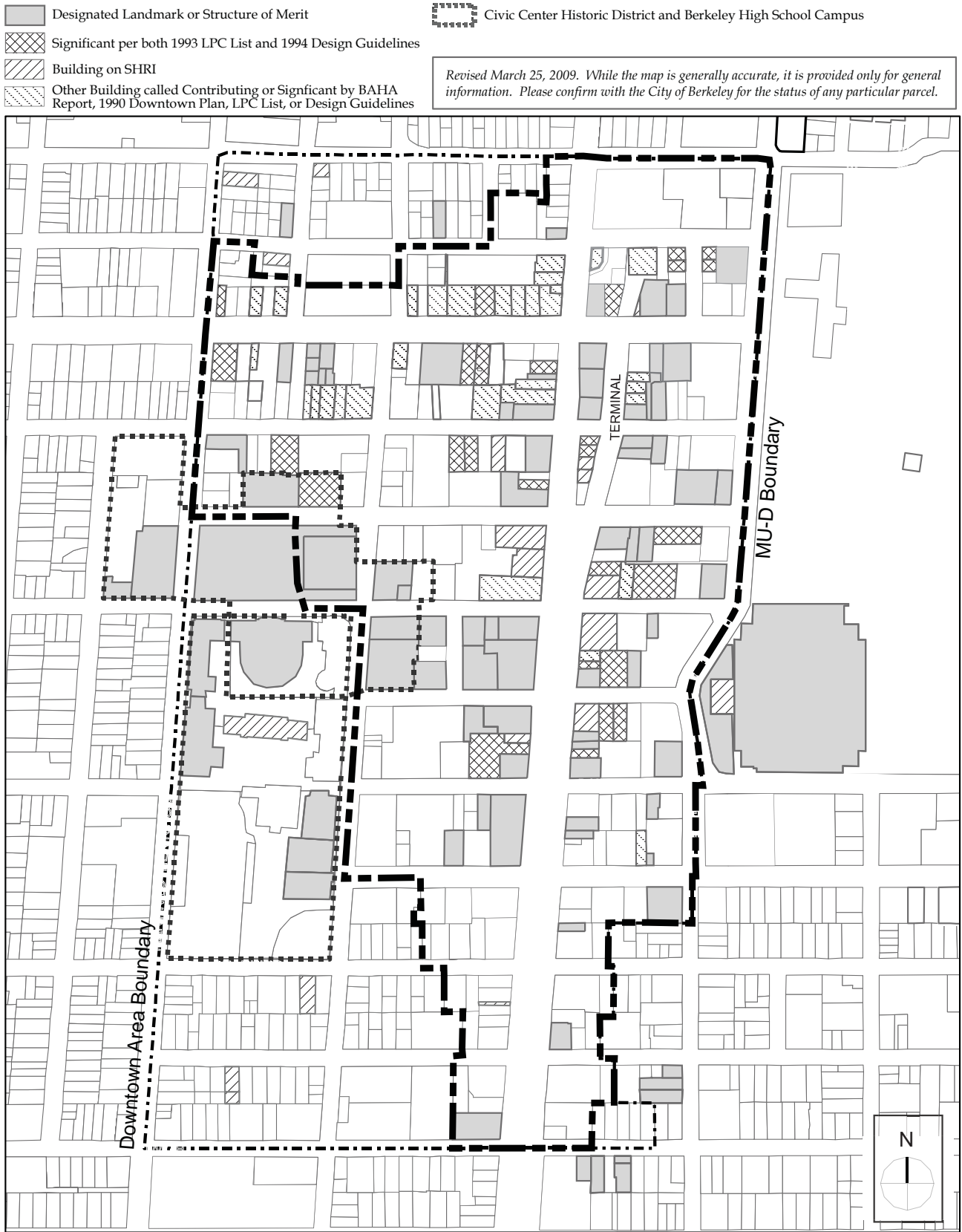

HISTORICAL OVERVIEW

- PERIOD OF SIGNIFICANCE
- TRANSPORTATION
FRAMEWORK
- 20TH CENTURY
DEVELOPMENT
- UNIVERSITY OF CALIFORNIA
- DOWNTOWN TODAY

HISTORICAL OVERVIEW



Parapet
often with balustrades or other ornament

Cornices
well defined and detailed, often slightly overhanging

Pilasters & Columns
round or square, sometimes fluted or paired

Horizontal Belt Courses
separating base, shaft, and capital

Upper Floor Windows
evenly spaced, sometimes grouped, with defined moldings, sometimes arched, mostly sash

Building Entries
well defined and treated with special care, sometimes with elaborate surrounds

Storefronts
reflect composition of upper floors, 15'-30' wide bays, transom windows above large display

Walls
brick, stucco, stone or terra cotta

Figure 6: Classic Revival. Old Masonic Temple (Source: Eli Cukierman).

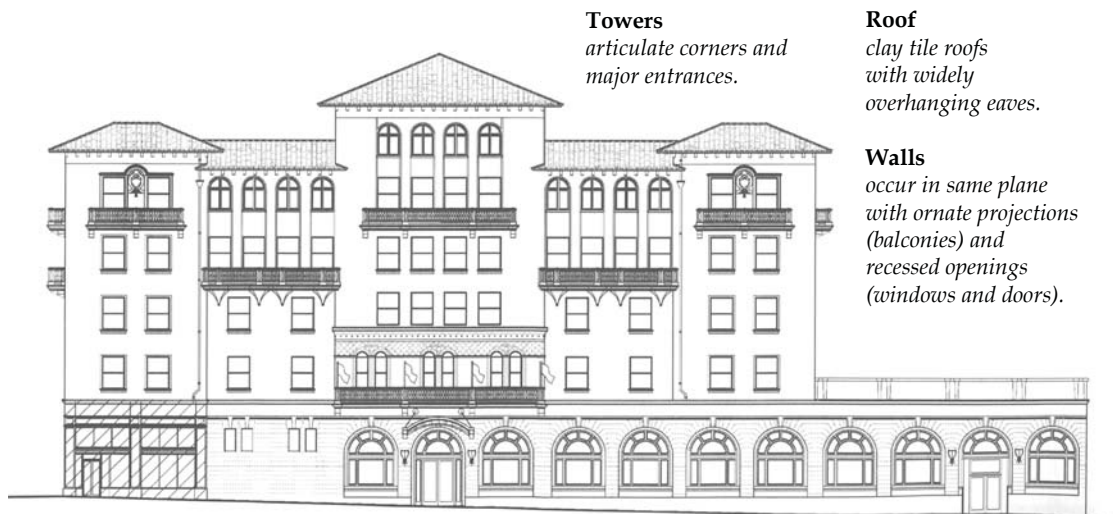

Towers
articulate corners and major entrances.

Roof
clay tile roofs with widely overhanging eaves.

Walls
occur in same plane with ornate projections (balconies) and recessed openings (windows and doors).

Building Entries
well defined accompanied by ornate overhang.

Windows
evenly spaced generally and grouped for compositional effect, highly transparent at street level.

Rusticated Base
Smooth masonry face contrasted by deep joints and edges.

Figure 7: Mission Revival. Shattuck Hotel

HISTORICAL OVERVIEW

Downtown Berkeley's historic character is established by the large number of intact buildings built between 1900 and 1940. Downtown's scale and historic character have been retained because traditional transportation and land use patterns have remained essentially the same, and there is a predominance of unified architectural styles.

PERIOD OF SIGNIFICANCE

The neo-Classic style and its variations – Mission, Mediterranean, Roman and Greek Revivals – were used for the majority of buildings in Downtown Berkeley. For example, a Classic vocabulary was used for Berkeley's first skyscraper, the Wells Fargo Building, the elaborate Masonic Temple, and even the small two-story, one-storefront-wide Alko Building. About half of Downtown's buildings were built before 1946.

With the exception of a few Art Deco style buildings such as the Kress Building and the Public Library. Most pre-1946 buildings share the common design elements of the Classic Revival styles. The Old Masonic Temple at the corner of Bancroft Way and Shattuck Avenue, shown below, exemplifies the Classical Revival style and the illustrates the three-part (tripartite) composition of neo-Classical styles:

- a **Base** of groundfloor and sometime mezzanine space, usually storefronts topped with a cornice.

- a **Shaft** comprised of most upper floors with pilasters running from an upper cornice (capital) to the cornice above the base to express of structural support.
- a **Capital** consisting of a parapet and sometime also the uppermost story.

Another example of a neo-Classical tripartite composition is the Shattuck Hotel between Allston and Kit-tredge. The Shattuck Hotel also illustrates features characteristic of the Mission Revival, such as terracotta elements and deep eaves.

Art Deco buildings are another stylistic tradition from the early twentieth century period of growth that characterizes much of Downtown. Art Deco compositions are also tripartite except that the "capital" is created by decorative elements and vertical pilasters breach the parapet and shape the silhouette.

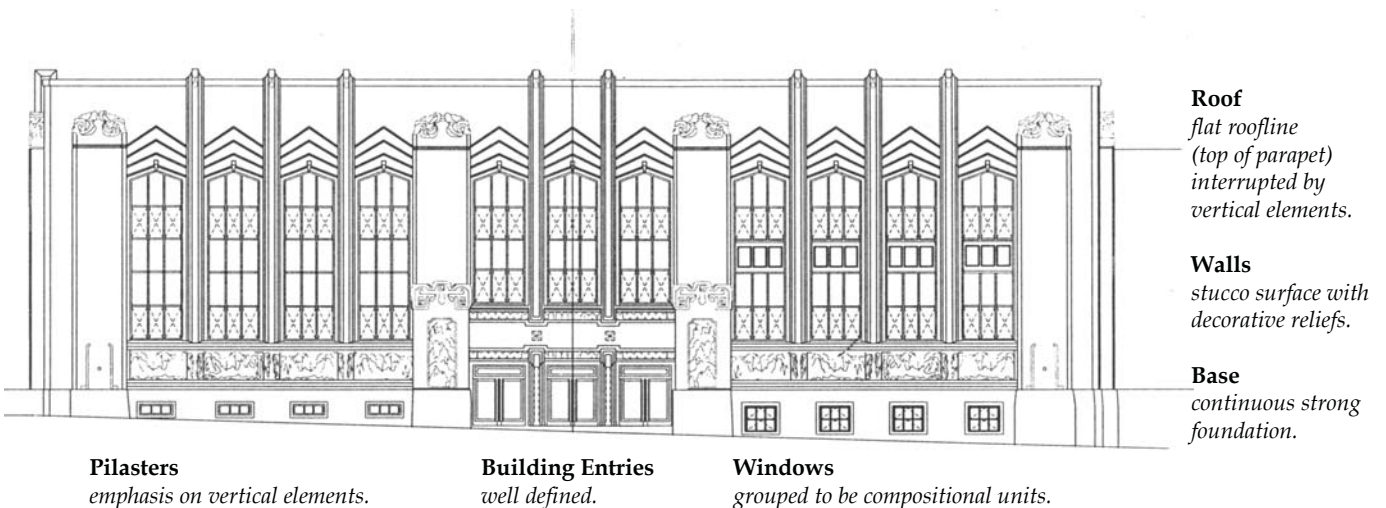

Figure 8: Art Deco. Central Library Berkeley.

HISTORICAL OVERVIEW (CONTINUED)

All of these traditional styles feature windows that are generally vertical in proportion, and may be regularly spaced or grouped to conform to stylistic traditions. Note that Downtown's buildings (old and new) form a continuous "streetwall" that runs next to street-facing property lines. The streetwall unifies and enclose intervening streets spatially. Passages and plazas may interrupt the streetwall but exceptions and not the rule. At ground level, a consistent streetwall maintains a line of interrupted shops and other active uses, thereby adhering to an important tenet for successful retailing.

TRANSPORTATION FRAMEWORK

Downtown Berkeley's form and location are the enduring results of transit patterns established in 1878 when Francis Kittredge Shattuck brought a Southern Pacific spur line from Oakland along Adeline Street through his property, terminating at Stanford Square, later to be named Berkeley Square, now Shattuck Square. Two streets, Shattuck and University, have always played major roles in the organization of the Downtown.

Since the beginning, Shattuck Avenue has been the heart of Berkeley's commercial activity, especially retailing. The original location of the station, freight yards,

and tracks was along Shattuck Avenue, which accounts for its extraordinary width. The urban scale of Shattuck Avenue was formed by the streetwall of contiguous buildings, built to maximize street frontage along the transportation corridor, with shops at ground level and office, residential, and hotel uses above. University Avenue served as the east-west horsecar route, joining Berkeley's early shoreline community of Ocean View with the rail-line and the hillside campus community. Because it is a transitional artery, development along University Avenue has historically been less dense than that along Shattuck Avenue. While the modes of transportation have changed over time, these two major transportation arteries continue to serve as the organizing framework for Downtown.

20TH CENTURY DEVELOPMENT

Dramatic growth and development in the early 1900s was stimulated by the advent of the electric rail system linking Berkeley to Oakland and San Francisco, the move of many San Franciscans to the East Bay after the 1906 earthquake and fire, and the growth of the University of California. At the turn of the century, wooden pioneer buildings were replaced with masonry structures, many of which were designed by such notable



Figure 9: Downtown Berkeley 1939. (Source: Berkeley Historical Society)

HISTORICAL OVERVIEW (CONTINUED)

architects as James W. Plachek and Walter H. Ratcliff, Jr.

The downtown buildings built during the first decade were stately and impressive, reflecting a sense of permanence and stability. Inspired by the City Beautiful movement, buildings incorporated neo-classical elements such as classic pillars, arches, and cornices, with stone or terra cotta ornamentation around building entries. A variation on the classic theme, Mission Revival, was equally popular, with its tile roofs, balconies, and square corner bays.

The 1920s saw another flourish of downtown development. New buildings were built on Shattuck square, which in 1923 was converted from the railroad terminal into a commercial block. The Shattuck Apartments and the twelve-story Chamber of Commerce Building (now the Wells Fargo Building) were built in the Classical Revival styles. Period Revival, Art Deco, and Moderne influences were prevalent through this decade. Recessed entries, tile and terrazzo pavings, marble, structural glass and metal storefronts, and prism glass transom windows are part of the visual vocabulary of this era, and many of these elements can be seen throughout the downtown area today.

Downtown Berkeley escaped much of the urban renewal which affected many California cities in the 1960s and early 70s. Demolition and new construction along Shattuck Avenue has been mostly limited to the BART construction era from 1966 and 1971, when two turn of the century high-rises at Shattuck and Center were demolished to make room for BART and two new bank buildings. In recent years, remodeling or replacement has usually been limited to single buildings at a time. As a consequence, the scale, massing, and layout of Downtown remain much as they were in the 1930s. Very few buildings comprising more than half of a block and most occupying a street frontage of 100 feet or less, and most buildings have a height between 2 and 5 stories – but with taller and smaller exceptions.

UNIVERSITY OF CALIFORNIA

The continued expansion of the University of California has influenced the growth patterns of the Downtown since the beginning of the century. University development has established well-defined edges to the Downtown and views of the hills have been retained and provide a welcome counterpoint to the built environment.

DOWNTOWN TODAY

Today, Downtown Berkeley is a well-defined area containing a large collection of early 20th Century buildings. Downtown is still the physical center of the city, and it retains the traditional attributes that make up a downtown transportation, affordable housing; civic and cultural life; and government and financial activities. Rare for a California city of its size, Downtown Berkeley has retained its original purpose and historic character, while showing evidence of a city which has adapted over time. The Downtown Area Plan places great emphasis on respecting the scale, use, and architectural character of Downtown Berkeley, while simultaneously encouraging architecture that addresses contemporary challenges with new forms of expression.

BUILDING DESIGN

All sections of this chapter are interrelated; refer to all of these sections and other chapters as appropriate.

- FACADES
The whole 'face' of a building from ground to roofline
- ROOF FORMS
- STOREFRONTS & ENTRANCES
The ground floor portion of the façade which faces the street, including retail or nonretail uses
- MATERIALS
- DETAILS & ORNAMENT
- COLORS
- LIGHTING, SECURITY & EQUIPMENT
- SPECIAL HISTORIC FEATURES
All existing buildings

F A C A D E S

The form, rhythm and character of Downtown established by its Landmark and Significant buildings should be reinforced and enhanced by renovation and new construction. Landmark and Significant facades should not be mimicked or trivialized, but should provide design guidance for new physical changes. Downtown area should have a unified visual identity which complements the historic character of its buildings, while allowing contemporary expressions.

ALL BUILDINGS

- 1 Reflect and reinforce the scale, massing, proportions, rhythm and attention to detailing which are established by the facades of Landmark and Significant buildings.
- 2 Refrain from false historicism. Do not trivialize or mimic Landmark or Significant buildings.
- 3 Incorporate elements which break up façade planes and create a visual play of light and shadow. Avoid long, uninterrupted horizontal surfaces. Consider the use of bay windows, balconies and architectural projections.
- 4 Vertical divisions of ground and upper floors should be consistent. Generally maintain a cornice that projects horizontally between the ground floor (and its mezzanines) and upper stories. Align the cornice and other horizontal ground floor elements (like awnings and sign bands) with similar features on neighboring buildings and storefronts, if feasible.



Figure 10: This façade composition, typical of Landmark and Significant buildings, shows how the ground floor is distinguished from upper floors, and how a consistent rhythm of storefront bays is maintained along sidewalk.

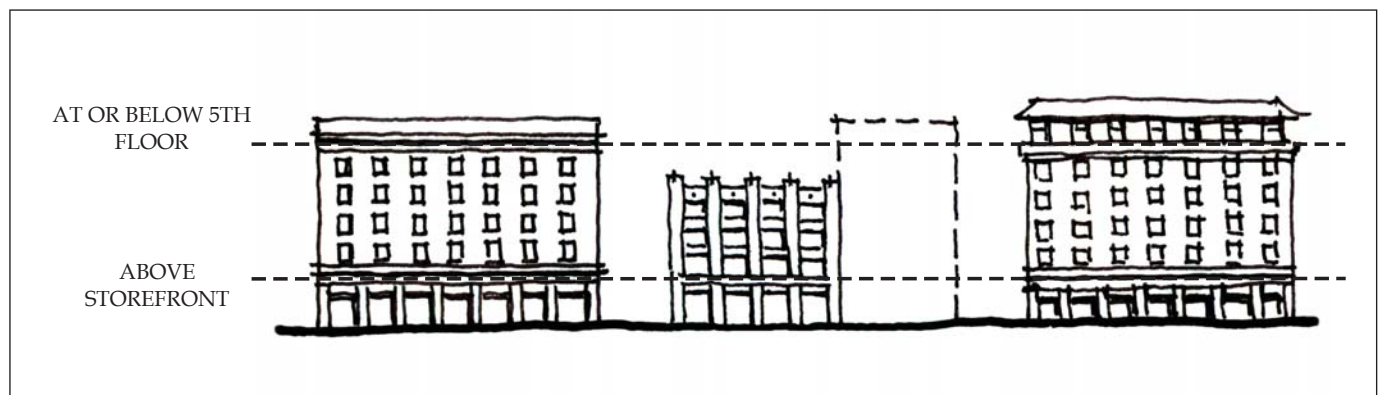
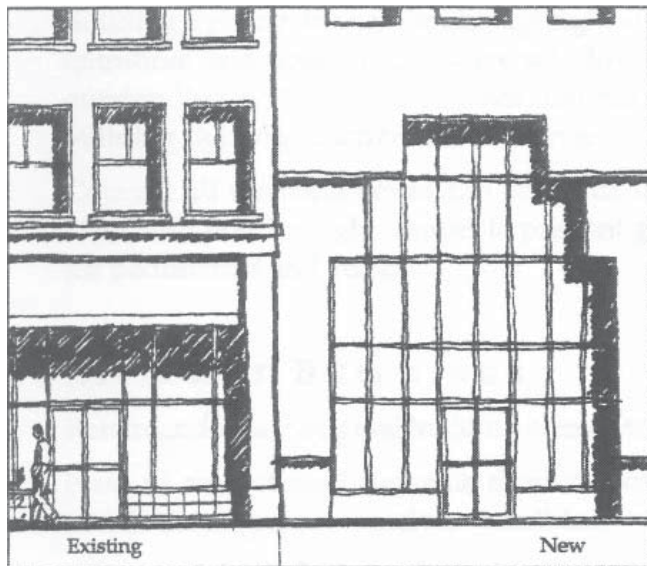

Figure 11: Consistent Cornice Lines. Maintain cornice lines between street level commercial and upper stories, and above 5th floor (or lower with less tall buildings).

FACADES (CONTINUED)



INAPPROPRIATE



APPROPRIATE

Figure 12: The façades of new and renovated buildings should respect the rhythm and proportions of Landmark and Significant buildings, and major horizontal elements should align with those on neighboring buildings.

- 5 Architecturally distinguish the ground floor from the upper façade, to form a visual base for the building. Create an intimate scale for the pedestrian environment.
- 6 Architecturally distinguish the upper façade from the top of the façade, to provide a visual termination for the building. Generally maintain a cornice that projects horizontally at the top of the 5th floor, or near the top of buildings that are less tall (see Figure 11).
- 7 The façades of Downtown’s historic buildings are comprised of load-bearing walls and frames, the limits of which give similar scale and expression. Maintain the typical rhythm of structural bays and enframed storefronts of 15-30 feet spacing at ground level, in order to enhance visual continuity with existing buildings and pedestrian scale. Curtain walls, if used, should be designed with rhythm, patterns and modulation to be visually interesting.
- 8 Articulate side and rear façades in a manner compatible with the design of the front façade. Avoid large blank wall surfaces on side and rear façades which are visible from public areas. In these locations, display windows, store entrances, and upper windows are encouraged. When this is not feasible, consider the use of ornament, murals, or landscaping along large blank walls.
- 9 Include architectural features such as awnings, canopies, and recessed entries that can protect pedestrians from inclement weather. Design these features as integral parts of the building.
- 10 Remove alterations whose design and/or materials are not consistent with the overall character of the building.
- 11 For alterations to existing buildings, improve the character of the building and its relationship to Downtown’s historic character. This is especially important for buildings with little architectural significance.
- 12 Use high quality detailing for new buildings and replacement elements. For example, new or replace-

FACADES (CONTINUED)

ment windows should have sash and frame thicknesses and window depths which are similar to those of original or historic windows. Such level of detailing provides an interplay between light and shadow which adds interest and visual depth to the façade.

- 13 Window should comprise 25-50% of upper facades visible from public areas, and should reflect the rhythm, scale, proportion, and detailing of upper windows of Landmark and Significant buildings.
- 14 Uncover original openings where possible, and do not block up existing openings. New openings should be in proportion to other openings and façade elements.
- 15 Place storm windows or screens on the interior so window exteriors are not visibly altered.
- 16 Operable windows are encouraged but should be accompanied with HVAC interlocks and other fea-

tures to avoid building operation and energy loss when windows are open.

- 17 Generally accompany windows with light shelves, overhangs or deep recesses to shade the window during the summer (when the sun is high in the sky) while providing solar access into the building during the winter (when the sun is low). Deeply recess west-facing windows and/or accompany them with vertical fins to reduce glare (i.e. extremely intense light from one direction) and solar gain during the hottest hours (See Figure 13).
- 18 Photovoltaic panels should either be integrated within the overall composition of facades, such as by serving as awnings or light shelves, or they should be screened from view.
- 19 Consider “double walls” to trap solar heat in the narrow space between outer windows and windows or walls that define usable rooms. On cold days, double walls trap heat to be used by abutting rooms. On hot

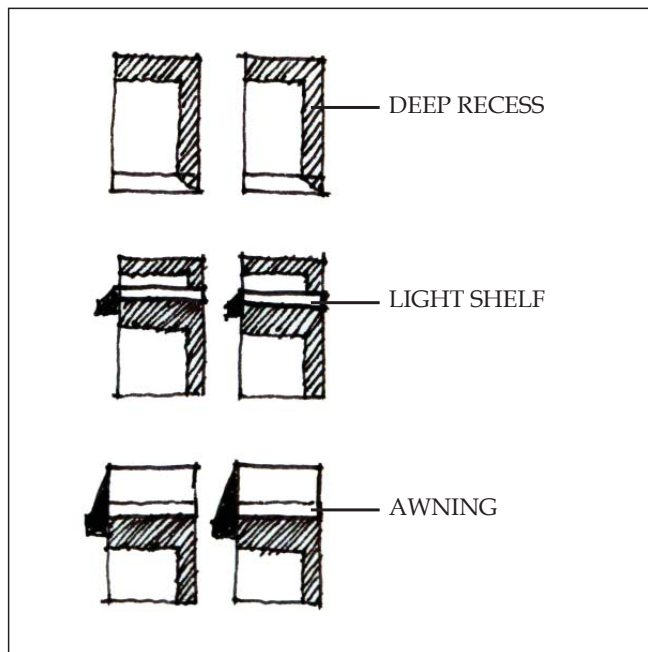

Figure 13: *Shading Windows.* Control sun and shade with architectural features.

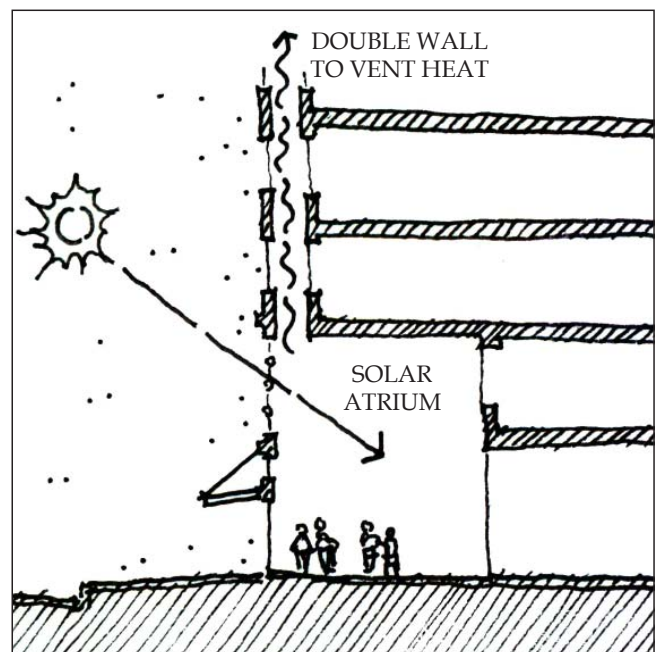

Figure 14: *Passive Solar.* Passive solar features can contribute to a building’s environmental performance. Integrate passive solar features in the design of facades, lobbies, etc.

FACADES (CONTINUED)

- days, double walls vent excess heat to the outdoors or redirected it to rooms that are shaded.
- 20 Frame windows and use light shelves and other articulation to emulate the rhythm, scale, and reveal (shadow) of traditional buildings (See Figure 13).
- 21 Building lighting, if any, should highlight signs, entrances and walkways, display windows, or outstanding architectural features. Do not use building lighting which blinks or changes.
- 22 Conceal all electrical boxes and conduits from view, and position light sources to prevent glare for pedestrians and vehicles.
- 23 Refuse and recycling bins should be concealed and incorporated within a building's envelope.
- 24 Consider the design of rooftops that may be viewed from above. Reduce glare and make rooftop equipment more attractive.

SIGNIFICANT BUILDINGS

- S1 Retain and repair original building elements
- S2 New or replacement elements should visually match the original as closely as possible.



Figure 15: This historic photo of the Shattuck Hotel illustrates several principles of façade design. The articulated roof profile and façade planes and the Hink's canopy lend interest and a "human" scale to what is in fact a very large building (Source: Berkeley Architectural Heritage Association).

F A C A D E S (CONTINUED)

S3 When original elements have been removed and are unknown, replacement should be visually compatible with the rest of the façade, and/or with the rhythm, proportion, and scale of nearby Landmark and Significant buildings.

- *When relevant, the previous guidelines for All Buildings also apply.*

LANDMARK BUILDINGS

L1 Preserve existing original facades. Make necessary repairs in a manner which does not harm historic building materials or details.

L2 Remove alterations whose design or materials are not consistent with the original design nor historically significant in their own right.

L3 Restore or rebuild missing or deteriorated façade features based on historic evidence, not conjecture.

L4 When restoring the façade is not possible, new alterations should have the ability to be removed, without adversely affecting original elements, in anticipation of future restoration.

L5 New or replacement elements should be exact duplicates of the original.

- *When relevant, the previous guidelines for All Buildings and Significant Buildings also apply.*

ROOF FORMS

Nearly all buildings of architectural significance in Downtown Berkeley have distinctive roof forms or details, which provide an attractive terminus for the building, and add visual interest to the skyline. New construction and façade alterations should continue the precedent of utilizing changes of height, profile, detailing, or materials in order to enhance the sense of enclosure that is established at roof level.

ALL BUILDINGS

- 1 Retain distinctive roof forms, profiles and cornices. Remove alterations which are not consistent with the original design nor significant in their own right.
- 2 Provide a termination to the top of the building in a way that complements and enhances the character of the building and the Downtown.
- 3 On sites which include corners, the roof design should emphasize the corner. Conceal all electrical boxes and conduits from view, and position light sources to prevent glare for pedestrians and vehicles.
- 4 “Ventilation towers” project vertically to create low-pressure air pockets that can be used to draw air out of buildings. Consider their use. While their aesthetic expression can vary, most ventilation towers are expressed as chimneys, cupolas, and slender towers. Ventilation towers work best with hot rising air, and the tower can be designed to absorb heat and aid ventilation (See Figure 16).

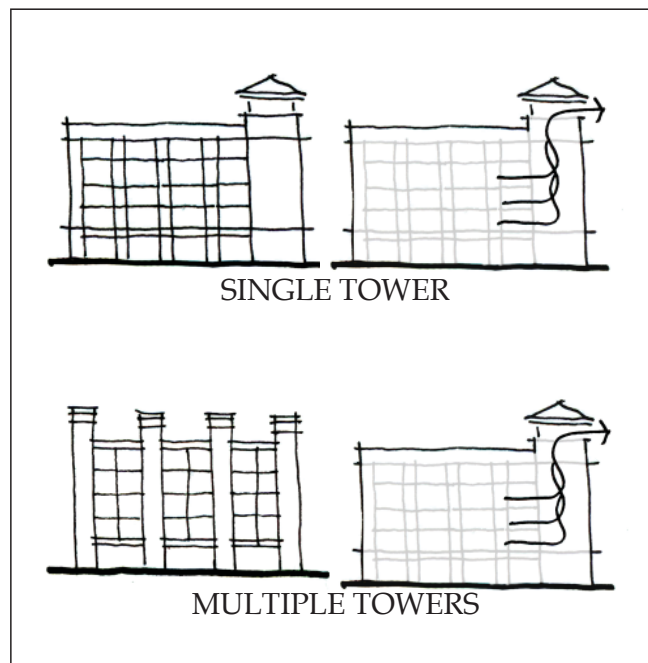

Figure 16: Ventilation Towers. By extending beyond the roof, towers may be used to help ventilate buildings and can find expression in a building's architecture.

ROOF FORMS (CONTINUED)

LANDMARK & SIGNIFICANT BUILDINGS

LS1 Restore or replace original cornices, brackets and other cornice ornamentation. Replication should be based on historic documentation, not conjecture. Use original materials if repair or replacement is required. Substitute materials should not be used on Landmark Buildings.

- *When relevant, the previous guidelines for All Buildings also apply.*

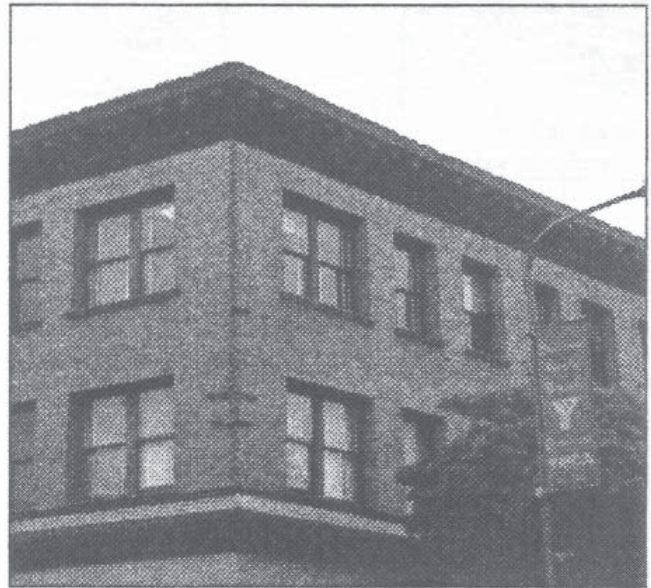

Figure 17: Downtown's Landmark and Significant buildings provide numerous examples of attractive rooflines, with both sloped and flat roofs. Flat roofs typically include an ornamental cornice and parapet.

STOREFRONTS & ENTRANCES

Many of the features desirable for a pedestrian oriented Downtown are precisely those found in the original storefronts of Downtown Berkeley's Landmark and Significant buildings. These features, which include inviting entranceways, continuous display windows, obvious locations for signs, and sensitively scaled proportions, should be incorporated into new as well as remodeled storefronts.

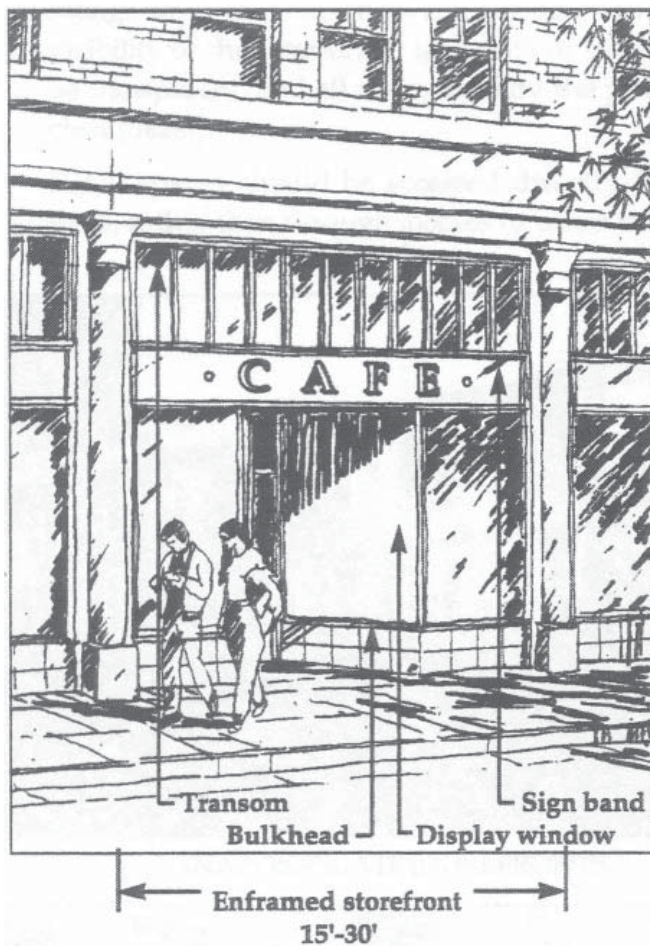

Figure 18: This storefront, typical of Landmark and Significant buildings, features several traditional storefront components: large display windows, a sign band, transom windows and a recessed entry. It is enframed and defined by the architectural elements of the façade, and continues the rhythm of storefront bays along the sidewalk.

ALL BUILDINGS

- 1 Maintain storefronts with generous windows along streets where commercial and higher levels of pedestrian activity can be expected (see Figures 18 and 19). Reflect the historic storefront rhythms and proportions found throughout Downtown. Fit storefronts within enframed openings.
- 2 Emulate traditional elements such as large display windows of clear glass, bulkheads, recessed entries, transom windows and suitable locations for signs. These elements should reflect the proportions and detailing of historic elements found on Landmark and Significant buildings. Storefront spaces should have taller ceilings (at least 15 feet high). This taller space should be expressed on the façade, generally with transom windows.
- 3 Retain original storefront elements which have achieved significance in their own right. Remove alterations not consistent with the original design nor significant in their own right.
- 4 Remove alterations which do not fit within the enframed storefront opening or whose design and/or materials do not contribute to the overall character of the building.
- 5 Multiple storefronts within the same building should be visually compatible in terms of scale, alignment, color, materials and historic elements. While the desire for tenant individuality is understandable, it is most important that the continuity of the building as a whole is not compromised.
- 6 Continue the rhythm of 15-30 feet enframed storefront openings at ground level, in order to reinforce visual continuity and pedestrian scale. Large, single tenant spaces must continue this appearance of individual storefronts.

STOREFRONTS & ENTRANCES (CONTINUED)



INAPPROPRIATE STOREFRONTS



APPROPRIATE STOREFRONTS

Figure 19: Inappropriate and Appropriate Storefronts.

- 7 Except for recessed entries, a majority of the storefront should be at the property line, and other recessed portions should not detract from streetwall continuity.
- 8 Design storefront entrances and windows to maximize the visibility for the interior. At least 75% of storefronts should be transparent, and all doors used by the public should be clear glazed.
- 9 Retail spaces should be accessed directly from the sidewalk, rather than through lobbies or other internal spaces.
- 10 Arcades may be utilized as long as the continuity of the streetwall is reinforced.

- 11 Clearly distinguish storefront entrances from entrances to lobbies or upper floors through the use of architectural treatments and materials selection.
- 12 Uncover original storefront elements that still exist. This includes entryways and paving, doors, transoms and display windows, hardware, glazing, frames, and other historic materials.

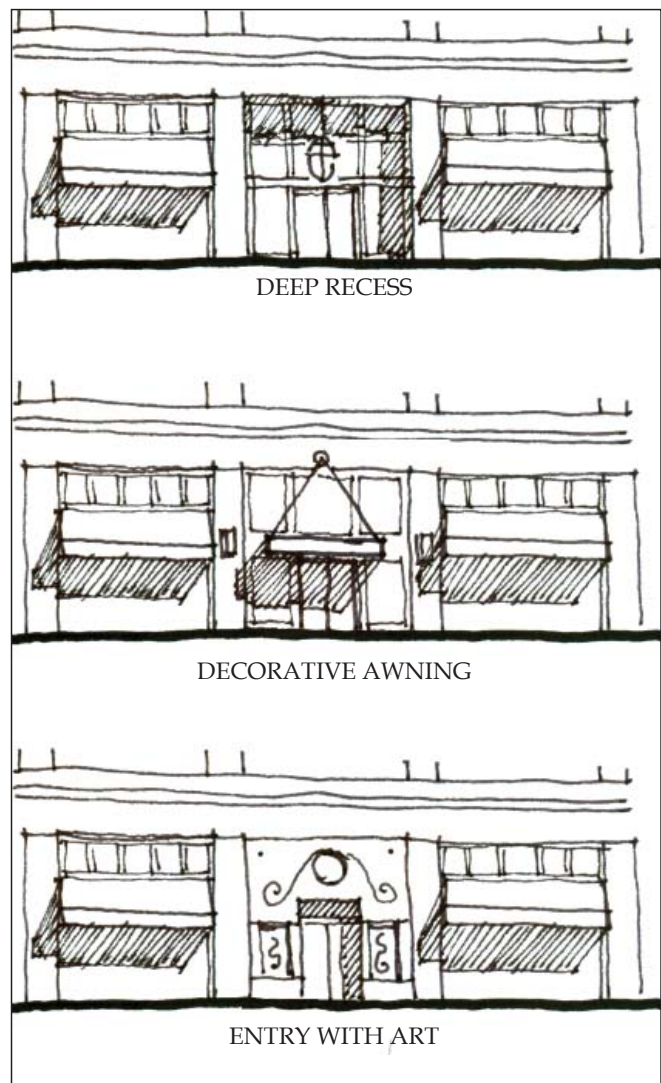

Figure 20: Entrances To Upper Stories. Announce entrances architecturally with deep recesses, decorative awnings, art, light fixtures, and transom windows. Provide generous lobbies (except for smaller projects) that are visible from the street.

STOREFRONTS & ENTRANCES (CONTINUED)

- 13 Do not cover existing entries, doors, or windows, even if they are no longer used.
- 14 Articulate side and rear storefronts in a manner which is compatible with the design of the primary storefront.
- 15 Clearly express ground floor entrances to upper-story uses on streets and other public spaces. For larger projects, ground floor entrances to upper story uses should include generous lobbies that can be seen from the street (see Figure 20).

SIGNIFICANT BUILDINGS

- S1 Retain original storefront elements, or elements which have gained significance in their own right, such as entries, doors, windows, frames and hardware. Repair rather than replace them if possible. Repair techniques should use the gentlest means possible, so as not to damage historic materials.
 - S2 Remove alterations not consistent with original designs nor significant in their own right.
 - S3 New storefronts and alterations should be compatible with the historic character of the façade in terms of colors, materials, and details. Locate entrances and doors to reflect original locations if known. Otherwise, reflect the entry patterns and storefront design of nearby Landmark and Significant storefronts.
 - S4 Replacement elements should match the original elements as closely as possible in terms of materials, profile, and detailing.
- *When relevant, the previous guidelines for All Buildings also apply.*

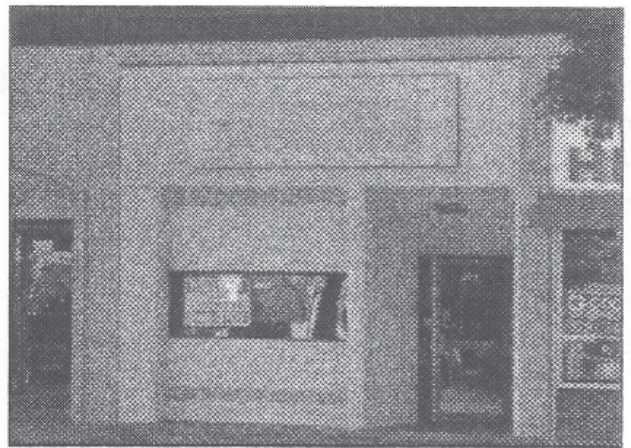

INAPPROPRIATE



BETTER



APPROPRIATE

Figure 21: Inappropriate and Appropriate Storefront Elements.

STOREFRONTS & ENTRANCES (CONTINUED)

LANDMARK BUILDINGS

- L1 Where original storefronts exist, restore them. Replicate missing or damaged elements based on historic evidence, not conjecture.
 - L2 Where original storefronts do not exist, consult historic photos to determine original conditions. Replicate the original locations and design of storefront elements, based on historic evidence, not conjecture.
 - L3 Remove alterations not consistent with original designs nor significant in their own right.
 - L4 Retain original storefront elements such as entries, doors, windows, bulkheads, frames and hardware. Repair rather than replace them is possible. Repair techniques should use the gentlest means possible, so as not to damage historic materials. If repair is not possible, replacement elements should be exact duplicates of the original.
 - L5 When original storefront elements such as doors, windows, and bulkheads have been removed and historic evidence of these elements is unknown, the new storefronts and alterations should respect and enhance the historic character of the building, and should utilize traditional components, materials, colors, and detailing,
 - L6 Locate entrances and doors to reflect original locations if known. Otherwise, reflect the entry patterns of nearby Landmark and Significant storefronts.
 - L7 Alterations which cover or obscure original elements should be able to be removed without damage to original building elements, in anticipation of future restoration.
 - L8 Alterations required due to code compliance or change of use shall respect the design and materials of the storefront. Consult the State Historical Building Code when code compliance issues arise.
- *When relevant, the previous guidelines for All Buildings and Significant Buildings also apply.*

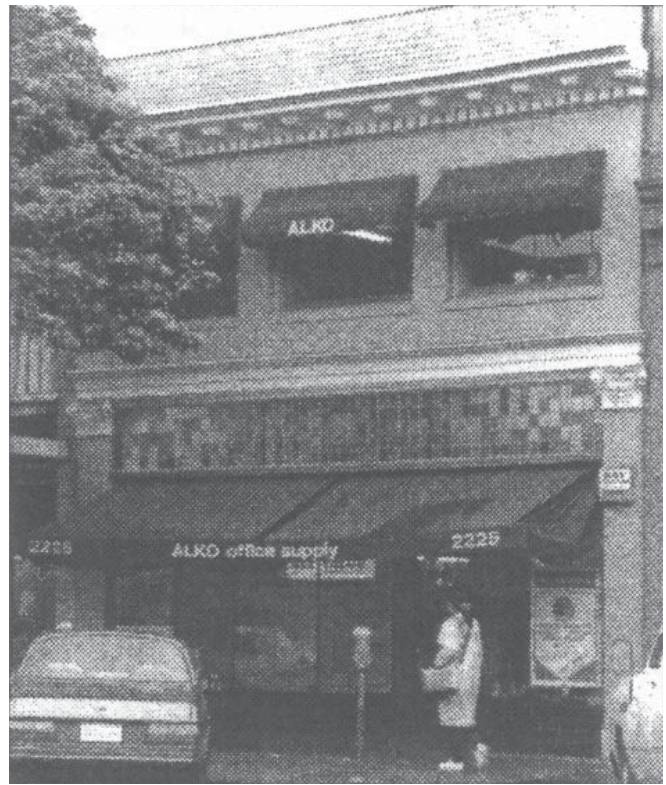

Figure 22: The Alko building at 2225 Shattuck is a fine example of restoration of an historic storefront, with its leaded glass transom and decorative pilasters.

MATERIALS

Many of the features desirable for a pedestrian-oriented Downtown are precisely those found in the original storefronts of Downtown Berkeley's Landmark and Significant buildings. These features, which include inviting entranceways, continuous display windows, obvious locations for signs, and sensitively scaled proportions, should be incorporated into new as well as remodeled storefronts.

ALL BUILDINGS

- 1 Preserve existing rare, unique, or high-quality materials.
- 2 Use high quality, durable materials which enhance the building and convey a sense of permanence. Materials should generally have a service life of at least 50 years.
- 3 Materials should be compatible with those used on nearby Landmark and Significant buildings, and should have a similar level of detailing.
- 4 Retain durable original wall materials such as brick, wood, copper or bronze window frames; structural glass, marble or tile bulkheads; and terrazzo paving.
- 5 Desirable façade materials for new or renovated facades includes brick, concrete, stucco, marble, granite, tile or terra cotta.
- 6 Use wood, aluminum, steel, copper, or bronze for window frames and sash.
- 7 Because they are experienced at close range, storefronts should have the richest and most durable materials on the building. Materials for storefronts can be different from those used on the upper façade. Bulkheads should be faced with tile or stone.
- 8 All glass on ground floors should be clear and non-reflective. Upper floor windows may have lightly tinted, but non-reflective glass. Stained, translucent, or decorative glass may be used for transom windows, and should be used where equipment or ventilation ducts would otherwise be visible. Apply only transparent sun screens or window film to glazing.
- 9 Sloped roofs visible from public areas should be of slate, tile, standing-seam metal or other high quality materials.
- 10 Use high-quality detailing for new and replacement materials. For example, new or replacement windows should have sash and frame thicknesses and window depths similar to those of original or historic windows.
- 11 Use materials which are easily cleaned, and will not be permanently damaged by graffiti.
- 12 Clean materials by using the gentlest means possible. Do not use sand or grit blasting, glass peening or other abrasive methods to clean vulnerable materials like wood, brick, stone, copper, or tile.

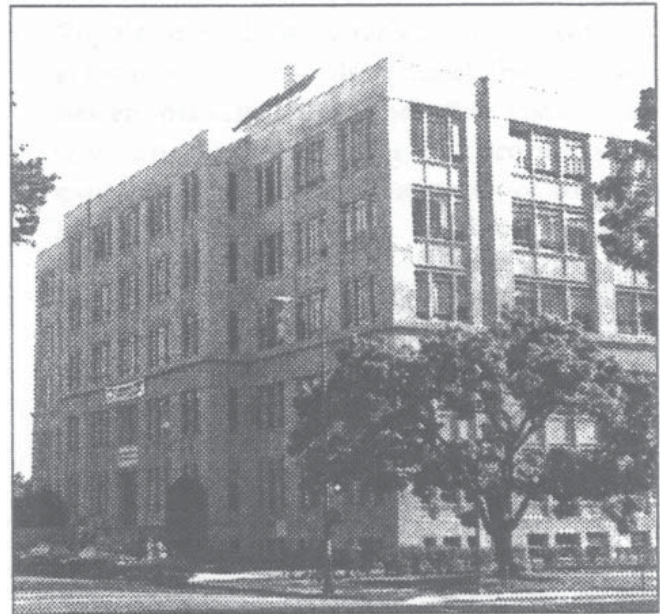

Figure 23: The Martin Luther King Civic Center, at 2180 Milvia, serves as an excellent model of what can be achieved with typical materials of plaster walls and metal windows.

MATERIALS (CONTINUED)

SIGNIFICANT BUILDINGS

S1 Retain original or significant building materials. Repair or replace materials with original or substitute materials which resemble the original as clearly as possible in design, color, texture and other visual qualities, and in their physical properties of expansion, contraction, absorption of moisture, and weathering.

- *When relevant, the previous guidelines for All Buildings also apply.*

LANDMARK BUILDINGS

L1 Retain and restore original or significant materials. Repair rather than replace materials if possible.

L2 Repair or replace materials with original or substitute materials which match the original in design, material, color, and other visual qualities, and in their physical properties of expansion, contraction, absorption of moisture, and weathering.

L3 New storefront materials should match the materials used on the original storefront. When this is not feasible, use new materials which match the design, detailing and quality of the original materials.

L4 Replacement windows should match the materials used on the original frames and sashes. When this is not economically feasible, use new materials which match the design, detailing and quality of the original materials.

- *When relevant, the previous guidelines for All Buildings and Significant Buildings also apply.*



INAPPROPRIATE

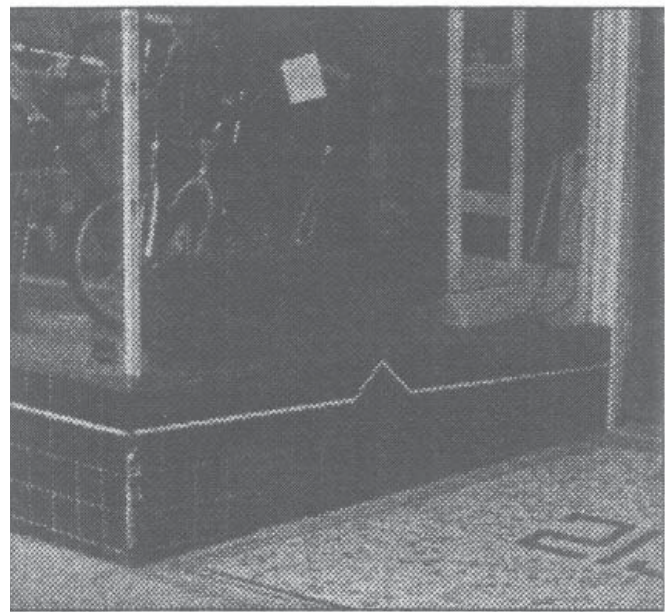

APPROPRIATE

Figure 24: On all buildings, durable original materials should be retained, not replaced by incompatible modern substitutes.

DETAILS & ORNAMENT

Downtown owes much of its character and richness to the ways that details and ornament have been incorporated in the design of buildings. Because the Downtown Area Plan emphasizes respect for the historic context of Downtown, alterations and new construction should provide a level of detailing that adds to and complements the ornate quality of the historic buildings found throughout Downtown.

ALL BUILDINGS

- 1 Building details and ornamentation should contribute to the architectural character of and artistic expressions in Downtown and should be integral to the design of façades. Avoid applying ornament just for the sake of decoration.
- 2 Incorporate details and ornament which are of a level of quality similar to those found on Landmark and Significant buildings.
- 3 Remove elements which obscure existing details or ornament.
- 4 Do not remove existing details or ornament, nor obscure them with signs, awnings, or façade changes.

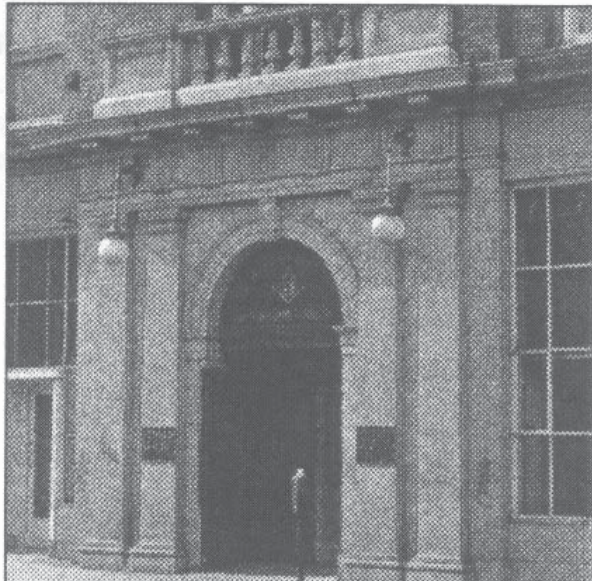

Figure 25: Ornament can have a design purpose beyond decoration. On the Old Masonic Temple, it is used to make the main entry clearly identifiable and welcoming.

- 5 Incorporate details and ornament which are in scale and harmony with the overall building façade, and which respect the historic character of the Downtown

LANDMARK & SIGNIFICANT BUILDINGS

LS1 Retain original details and ornamentation. Use historic evidence to replicate missing or deteriorated details and ornamentation.

LS2 Remove alterations which hide original detailing.

LS3 Remove alterations not consistent with original designs nor significant in their own right.



APPROPRIATE

INAPPROPRIATE

Figure 26: Alterations like the storefront on the right, which hide original detailing or are inconsistent with the design of Landmark or Significant buildings, should be removed.

COLOR

Color is a very powerful design tool and can have an enormous influence on the way a building or area is perceived. Most buildings in Downtown are faced with concrete, masonry, tile, or stone, resulting in a predominance of light earth tones. Downtown should project an image of quality, harmony, and cleanliness through the use of sensitive and compatible color schemes.

ALL BUILDINGS

- 1 Use colors which are harmonious with the prevalent earth-tone colors of downtown. Be a good neighbor. Don't detract from the Landmark and Significant buildings in Downtown.
- 2 Keep color schemes simple, using the minimum number of colors necessary to achieve the desired appearance.
- 3 Avoid strong or dark colors on large wall surfaces. For these areas, use colors which are muted and harmonious with the major colors found on nearby Landmark and Significant buildings. Reserve bolder colors as accents for building details, ornamentation, or special features.
- 4 Regularly maintain painted surfaces. Prior to repainting, carefully remove built-up paint or stains which obscure buildings details and ornamentation.

SIGNIFICANT BUILDINGS

- S1 Do not cover natural or previously unpainted surfaces such as brick, stone, tile or terra cotta. If it is necessary to unify color due to patching or repair, stain is preferable to paint because of its translucency.
 - S2 Remove stains, paints and other coloring agents using the gentlest means possible. Do not use sand or grit blasting, glass peening or other destructive methods.
 - S3 Highlight building details, ornamentation and special features to differentiate them from the rest of the building.
- *When relevant, the previous guidelines for All Buildings also apply.*

LANDMARK BUILDINGS

- L1 Restore and maintain surfaces in their original condition. If paint is to be removed, use removal methods which will not harm the historic materials.
 - L2 Use original colors of paints, stains, or other coloring agents if they are known.
- *When relevant, the previous guidelines for All Buildings and Significant Buildings also apply.*

LIGHTING, SECURITY & EQUIPMENT

Areas that are perceived as safe and secure are clean, well lit, and active. This sense of security promotes a high level of use and discourages crime and vandalism. In the pedestrian-oriented Downtown Area, lighting should be brightest at sidewalks and storefronts, and building equipment should be located so it is neither seen nor heard from public areas. An objective for Downtown Berkeley is to create a safe and inviting environment which, due to its variety of commercial, retail and residential uses, encourages pedestrian activity and vitality at all hours.

LIGHTING

- 1 Provide lighting at building entrances and for security at ground level.
- 2 Provide accent lighting to highlight interesting architectural features.
- 3 Design and locate light fixtures which coordinate with and complement the architectural style of the building.
- 4 Lighting should be integral to the design of the building or site.
- 5 Shield lighting so as to avoid direct glare into adjacent uses.
- 6 Exterior surface-mounted grilles are not recommended, and will be allowed only if they are covered by an awning or fascia. Grilles which are placed inside the building and allow visibility to the display windows are preferred, rather than exterior surface mounted grilles.
- 7 Reverse-mounted security grilles can often be concealed within the storefront fascia, rather than protruding onto the building.

SECURITY

- 1 Good lighting and alarm systems are the preferred method for addressing security concerns.
- 2 Housings for security grilles should be unobtrusive. Scissor and accordion grilles are discouraged unless they are completely concealed when not in use.
- 3 Security grilles and tracks should be carefully integrated into the storefront design and should be completely concealed when not in use.
- 4 Roll-down grilles should be see-through rather than solid grates. This provides views of the interior when stores are closed.
- 5 Permanently attached interior or exterior security bars are not allowed.

EQUIPMENT

- 1 Building equipment, including air conditioning units, pipes, ducts, meters, transformers and dumpsters must be enclosed, buried, or otherwise concealed from public view, including views from nearby buildings.
- 2 Locate and design required vents and access doors to minimize their visibility from public spaces.
- 3 Direct exhaust fumes from mechanical equipment away from sidewalks and other pedestrian areas.

LANDMARK & SIGNIFICANT BUILDINGS

- LS1 Do not damage or obscure historic materials when installing lighting, security, or equipment devices.
- *When relevant, the previous guidelines also apply.*

SPECIAL HISTORIC FEATURES

Historic features such as balconies, towers, and fire escapes contribute to the rhythm and interest of the street, and are unique visual assets to Downtown Berkeley. In most cases, these features should be preserved and restored.

ALL BUILDINGS

- 1 Retain original balconies, towers, and fire escapes where they still exist, and where they add interest to and enliven the downtown environment.
- 2 Consult historic photographs to identify special or historic features of the building or site. Replicate missing or deteriorated features if they would add to the character of the building and the Downtown. Replication should be based on historic evidence, not conjecture.
- 3 Incorporate special features typically found on Landmark and Significant buildings, such as corner towers, balconies, bays and friezes. These special features should be in scale and harmony with the overall building façade, and should enliven the building as well as the architectural character of the Downtown.
- 4 Special features should incorporate a level of detailing which is similar to that found on Landmark and Significant buildings.



Figure 27: The restored friezes on the Berkeley Library enrich and enliven what are otherwise blank ground-floor façade.

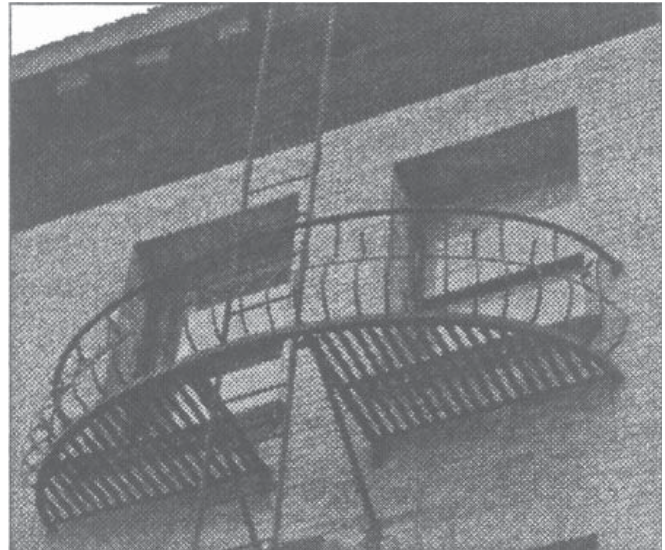

Figure 28: Many balconies and fire escapes feature ornamental ironwork which adds character to the buildings they adorn.

AWNINGS & CANOPIES

- GENERAL
- AWNINGS
- CANOPIES
- MARQUEES

AWNINGS & CANOPIES

Awnings and canopies provide sun and rain protection to pedestrians, provide a sense of enclosure at sidewalk level, are good locations for pedestrian-related signs, and shield window displays from the sun. awnings and canopies must respect the architectural integrity of the façade on which they are placed, the context of their location, and the historic character of Downtown.

GENERAL

- 1 Work which involves the installation or repair of any awning, canopy, or marquee must secure design approval and the required permits prior to fabrication or construction.
- 2 Respect the architectural integrity of the façade on which these attachments are placed, the context of the building's location, and the historic character of Downtown.

AWNINGS

- 1 Fit awnings within enframed storefronts.
- 2 Awning shape, size, material and color should be considered with the architectural style and character of the building.
- 3 Awnings should be compatible with other awnings nearby, particularly those on the same building, when these awnings complement the architectural character of the building.
- 4 New awnings should be compatible with adjacent Landmark and Significant buildings.
- 5 The height of awnings should provide pedestrian scale to the building and meet code requirements. Locate the structural components of awnings at least 8 feet above the sidewalk. Unrestricted valances or returns should be at least 7 feet above the sidewalk, and may project no more than 2/3 of the width of the sidewalk.
- 6 Awning shape, size, and height should be proportional to the façade on which it is placed. Awnings should not be dominant or overwhelming elements.



Figure 29: Awnings should be designed as integral parts of the façade; they should complement the architectural style of the building and fit within enframed storefronts.

- 7 Use matte canvas fabric for awnings; not vinyl, fiberglass, plastic, wood or other unsuitable materials. Glass and metal awnings may be appropriate for some buildings, but must be consistent with the architectural style of the building and the historic character of Downtown.

AWNINGS & CANOPIES (CONTINUED)

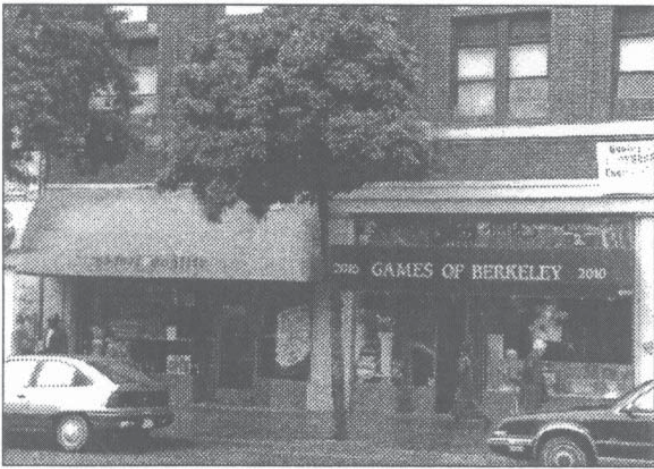

INAPPROPRIATE

APPROPRIATE

Figure 30: The awning at right fits within the enframed storefront and exposes the transom. The awning at left is over scaled for its storefront, and obscures the cornice and transom.

- 8 Attach awnings in a manner which does not harm historic fabric nor obscure architectural elements or details.
- 9 On Landmark and Significant buildings, operable awnings and preferred over stationary awnings because they are more historically accurate.
- 10 The shape, profile, materials, and location of awnings for Landmark and Significant buildings should be based on historic evidence or should be of a style which is consistent with the historic style of the building.
- 11 Because of solar orientation, architectural style, or detailing, some buildings are not adaptable to awnings; don't force awnings on these buildings.
- 12 Backlighting so that light shines through the awning material, and awning soffits which cover the bottom of the awning are discouraged.
- 13 Open sides on awnings are encouraged.
- 14 Awnings with large flat valances are strongly discouraged.

CANOPIES

- 1 Use canopies only on ground-floor facades, and design them to fit within enframed storefronts or over main entries.
- 2 Design canopies that complement and reinforce the architectural character of buildings.
- 3 Locate canopies at least 8 feet above the sidewalk, and at least 1.5 feet from the curb line.
- 4 For Landmark and Significant buildings, base the design and materials of canopies on historic evidence.
- 5 Attach canopies in a manner which does not harm historic fabric nor obscure architectural elements or details.
- 6 Direct canopy lighting toward the display windows or downward onto the sidewalk.

MARQUEES

- 1 Retain and restore marquees which are architectural assets to the building, including neon lettering and other interesting details.
- 2 Design new marquees only for entries to theatres, concert and recital halls (this does not include night clubs or restaurants). Marquees should be compatible with the character and scale of the building, and should comply with the guidelines for Marquee signs.
- 3 Marquees may contain internally lit areas to illuminate changeable venue lettering only.

SIGNS & GRAPHICS

- ALL SIGNS
- WALL SIGNS
Single-faced signs affixed directly to a building
- PROJECTING SIGNS
Signs which project from and are supported by a building, usually at a perpendicular angle
- WINDOW SIGNS
Signs on or behind windows
- AWNING, CANOPY, OR MARQUEE SIGNS
- MURALS
- SIGN BANNERS
- SIGNS ON TALLER BUILDINGS

SIGNS & GRAPHICS

Signs are an extremely visible part of the streetscape, and should reflect the quality of goods and services being offered Downtown. They should communicate an image of excellence, distinctive craftsmanship, and creativity, and should reinforce the unique and historic character to Downtown.

ALL SIGNS

- 1 Sign design and permit approval must be obtained prior to fabrication and installation of the sign.
- 2 Signs should reflect the character of the building and its use. When the building has little or no architectural character, it is imperative that the sign design adds interest and beauty to the façade.
- 3 Respect the immediate context of the building's location, and the historic character of Downtown.
- 4 The architecture of the building often identifies specific locations for signs, and these locations should be used.
- 5 Signs should be an integral part of the design of storefront alterations and new construction. Signs should not obscure architectural elements such as transoms or columns, nor appear cluttered.
- 6 The size of signs and sign letters should be in scale and proportional to the space in which they are located, with letters typically between 6 and 16 inches high.
- 7 Sign letter and materials should be professionally designed and fabricated.
- 8 Primary signs should contain only the name of the business and/or its logo. Secondary text which identifies products should be located in a secondary location.
- 9 Locate signs for ground floor tenants at storefront level. Signs on the upper façade should be building identification signs only.
- 10 Construct signs using high-quality materials such as metal, stone, wood, gold leaf, and exposed

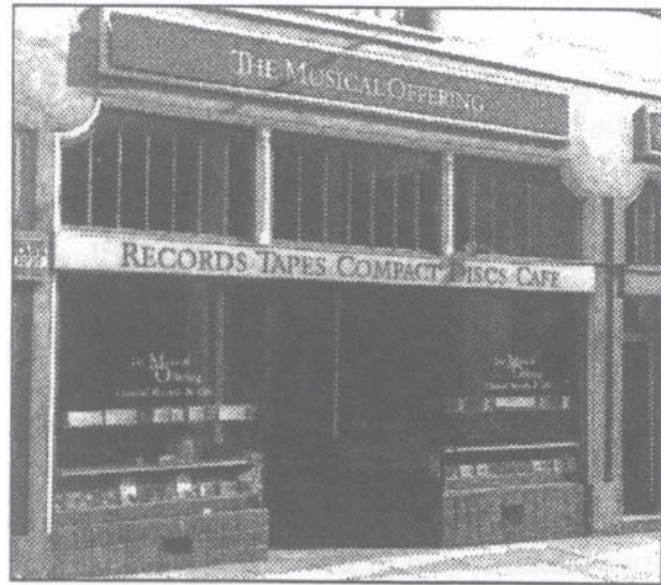

Figure 31: Wall signs should be an integral part of storefront designs, and should fit within or just above the enframed storefront. In both the above examples, the size and placement of the signs not only respect the composition of the building, but are also at a suitable scale for a pedestrian-oriented district.

SIGNS & GRAPHICS (CONTINUED)

neon. Signs should be a matte finish so as to not cause glare. Internally lit plastic letters or signs are strongly discouraged.

- 11 Firmly anchor the sign to the building in a way that does not damage the surface, and allows for easy removal to accommodate the changing tenants.
- 12 Coordinate the design and alignment of signs on multiple use buildings in order to achieve a unified appearance rather than visual confusion.
- 13 Retain historic signs and inscriptions, and do not remove or replant historic ghost signs. If it is necessary to remove or relocate historic signs, store them on the premises for future reuse.
- 14 On Landmark buildings, signs should be designed and located to be consistent with the character of the building and the era in which the building was constructed.
- 15 Modify historic signs for new use only to the extent that the changes are compatible with the original sign. Modifications should have the ability to be removed without affecting original elements, in anticipation of future restoration.
- 16 Modify corporate logo signs to conform to these guidelines, if necessary.
- 17 Cabinet signs are strongly discouraged; if used on existing, permitted signs, illuminate only the individual lettering or symbols, not the entire sign face.
- 18 Sign lighting, if any, should utilize spot-lighting, halo lighting, or exposed neon. Spot lighting should be inconspicuous or an integral design feature of the sign, and should not cause glare for pedestrians or motorists. Do not use sign lighting which blinks or flashes.
- 19 In addition to these guidelines, all signs must conform to the City of Berkeley Sign Ordinance. Design approval and sign permit must be obtained prior to sign fabrication.
- 20 Temporary signs should use high-quality graphics and must be removed within 30 days.

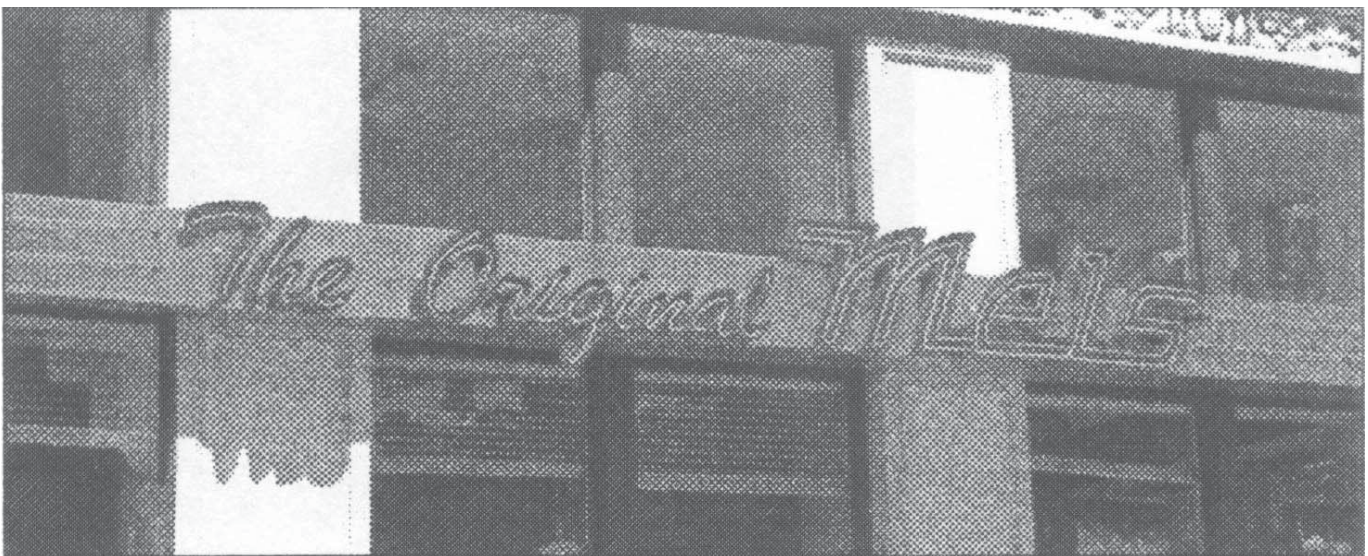

Figure 32: Exposed neon is encouraged as a means of sign illumination.



Figure 33: Symbol or icon signs provide added visual interest.

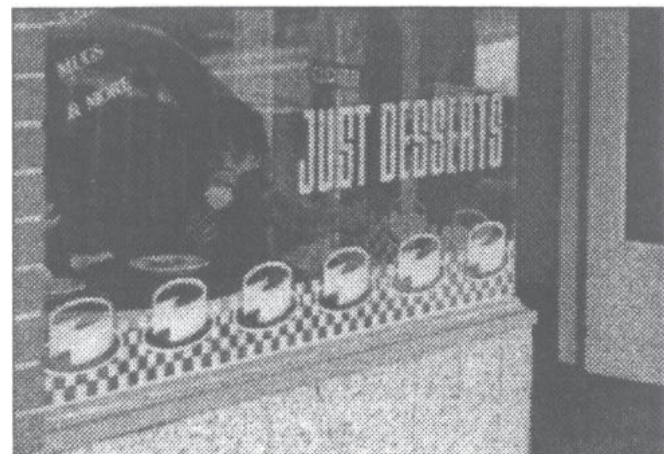

Figure 34: Window sign allowing clear visibility into store.

WALL SIGNS

- 1 Locate wall signs on the upper portion of the storefront, within or just above the enframed storefront opening. The length of the sign should not exceed the width of the enframed storefront.
- 2 Design signs which are compatible with the storefront in scale, proportions, and color.
- 3 Cabinet signs are strongly discouraged.
- 4 Maximum heights should generally not exceed 2 feet, with characters between 6 and 16 inches high. Signs should project no more than 9 inches from the building's face.

PROJECTING SIGNS

- 1 Design and locate signs which are compatible in scale, proportion and design with the façade. Rectangular signs should typically be vertically oriented and of minimal size (under 12 square feet per face)
- 2 Symbol or icon signs are preferable to worded projecting signs because they add visual interest to the street.
- 3 Do not locate projecting signs on the upper façade unless clear historical evidence of their use exists.

Locate projecting signs over pedestrian rights-of-way, not public streets.

- 4 Mount projecting business signs perpendicular to the façade of the building, and at least 8 feet above the sidewalk. The outside edge must be at least 1.5 feet from the curb line, and no more than 5 feet from the face of the building.
- 5 Mounting hardware should be an attractive and integral part of the sign design.

WINDOW SIGNS

- 1 Storefront window signs encourage pedestrian interest. Window signs should not exceed 15% of the window area so that visibility into and out of the window is not obstructed.
- 2 Use high-quality materials and techniques such as paint, gold-leaf, neon, and sandblasted or etched glass.
- 3 Apply window signs directly to the interior face of the glazing, or hang signs inside the window. Cancel all mounting of hardware and equipment.
- 4 Use high-quality graphics for temporary wall signs and advertisements. These must be removed after 30 days.



Figure 35: Awning signs should be limited to vertical surfaces.

AWNING, CANOPY OR MARQUEE SIGNS

- 1 Locate signs only on the vertical surfaces of awnings and canopies. The height of the characters should be less than 65% of the height of these vertical surfaces. On some canopies, it may be appropriate to locate letters above the top edge.
- 2 Product signs are not allowed on the front of the valance or canopy. Secondary text should be reserved for awning returns and canopy ends.
- 3 Install new marquee signs only on buildings occupied by theatres (film and live), concert and recital halls.

MURALS

- 1 Locate murals only on blank walls, security doors, or temporary areas such as construction fencing.
- 2 Murals which contain advertising are prohibited.
- 3 Mural subjects should not be threatening or intimidating to people.

SIGN BANNERS

- 1 Cloth banners can help to add interest and color to blank facades and special buildings. They should typically be vertically oriented and compatible with the overall character and color of the building.
- 2 Banners should look like architectural elements of the building, not flags, and should be attached at the top and bottom.
- 3 Banners which include text are also signs, and guidelines for All Signs and Projecting Signs also apply.
- 4 Banners should be at least 8 feet above the sidewalk, at least 1.5 feet from the curb line, and should project no more than 3 feet from the building façade.
- 5 Use canvas rather than vinyl, plastic, metal or other materials.
- 6 Temporary signs should use high-quality graphics and must be removed within 30 days.

SIGNS ON TALLER BUILDINGS

Architecture, not advertising, should define the upper elevations of buildings, especially those visible from beyond the Downtown. Commercial signage, advertising signage (including emblems or logos) or building name signage should be avoided on adjacent to the roofs of buildings in Downtown.

NOTE: DRC considered whether signage should be limited to below a certain height to avoid the "commercialization of Berkeley's skyline." No recommendation was made.

S I T E D E S I G N

This section applies primarily to new construction projects, but may also apply to projects which change the form, size, or configuration of existing buildings. All previous sections of these guidelines also apply.

- FRONTAGES, SETBACKS, & HEIGHTS
- HEIGHTS
- OPEN SPACES
- PARKING & LOADING

FRONTAGES, SETBACKS & HEIGHTS

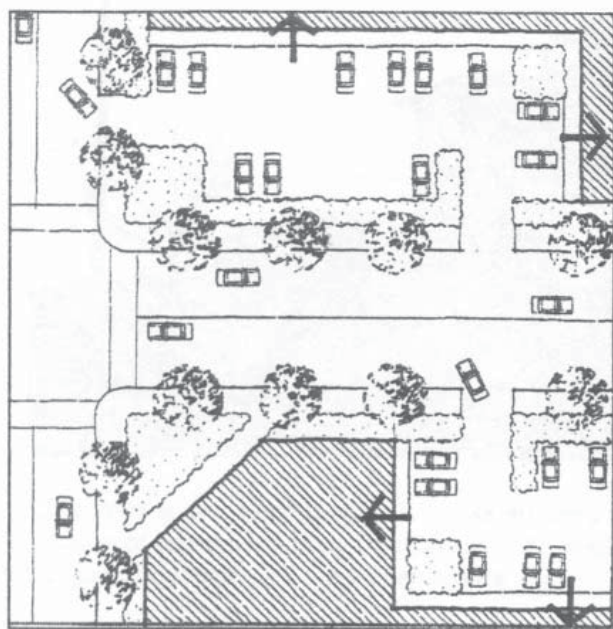

INAPPROPRIATE

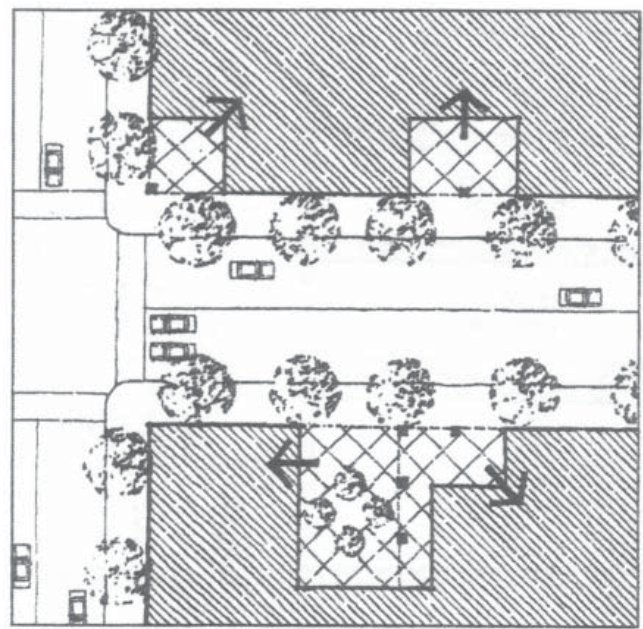

APPROPRIATE

Figure 36: Except for appropriately defined open spaces, special corner features or recessed entrances, a continuous zero setback should be maintained at the ground floor.

FRONTAGES, SETBACKS & HEIGHTS

Buildings should frame and define the street as an active public space. Throughout Downtown, buildings are typically built to street-facing property line(s). This historic ‘streetwall’ of facades should be preserved, and extended through new construction. Setbacks at the ground or upper floors may be used selectively to preserve sunlight, enhance views, provide open space or improve scale relationships, but should be designed with care to insure that visual continuity of the streetwall is not disrupted.

ALL BUILDINGS

- 1 Maintain a continuous zero-setback “build-to line” at the ground floor at the edge of all Downtown streets where commercial and higher levels of activity is anticipated, as has been indicated in the map “Public Serving Frontages” (see Figure 43). The only exceptions to this may be to: provide suitably defined, usable open space; create a special corner feature; provide recessed storefront entrances; create an arcade; to provide a narrow band of landscaping (see Figure 37); or to give emphasis to a civic building.
- 2 On Downtown streets without commercial or higher levels of activity, bring buildings close to the street-facing property line while also providing landscaping.
- 3 Continue the rhythm of 15-30 foot spacing of structural bays and/or enframed storefronts at ground level, in order to establish visual continuity with existing buildings and create pedestrian scale.
- 4 Design recessed storefront entrances so they do not exceed 50% of the width of the storefront, nor ten feet in depth.
- 5 Consider massing alternatives that would reduce shadow impacts on streets and relate new construction to the scale of nearby buildings, such as use of upper-story setbacks. Consider ways that buildings with upper-story setbacks can avoid the “wedding cake effect,” such as by setting street-level entrances back to the same vertical plane as upper floors and/or by incorporating features that tie the building together visually (see Figure 38).
- 6 For new construction projects located on narrow east-to-west streets and over 75 feet in height, prepare an analysis of shade impacts on public open spaces and pedestrian sidewalks across the street. East of Shattuck, analyze visual impacts of ridge-line views to the east. Based on such analysis/analyses, consider upper floor setbacks, setbacks at street corners or other techniques to mitigate negative impacts. (see #12 for Wind Impacts.)
- 7 Place entrances to storefronts and other ground floor uses so that they are accessible directly from the public sidewalk, not internal lobbies.



Figure 37: Continuous Streetwall and Landscaped Setbacks. A narrow band of landscaping can add greenery to Downtown while maintaining a continuous streetwall.

FRONTAGES, SETBACKS & HEIGHTS (CONTINUED)

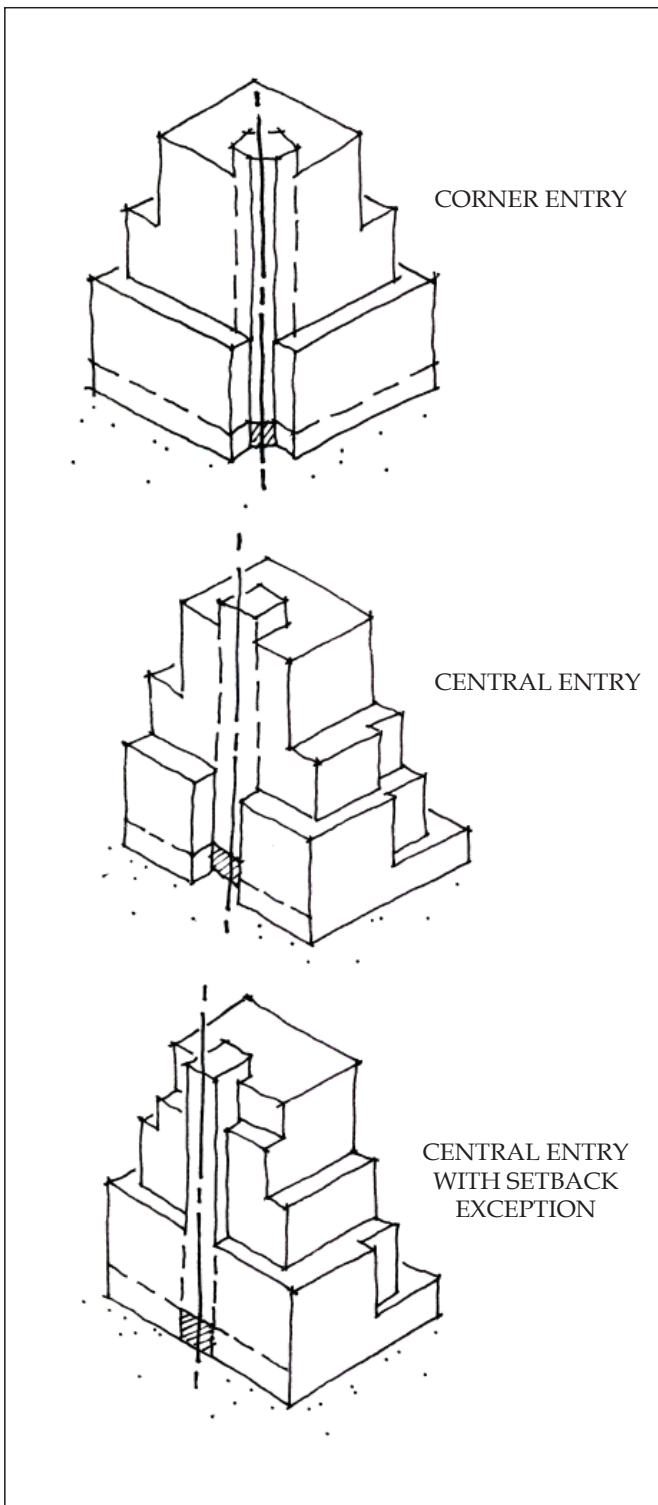

- 8 Design entrances of individual buildings to contribute positively to the street. Main entries should be clearly identifiable and inviting, and located to encourage interaction between open space and pedestrians.
- 9 New curb cuts in the Downtown core area are discouraged. Existing driveways may be relocated or replaced.
- 10 Maintain and reinforce Downtown's historic street-wall at the property line. Upper floor setbacks are desirable above 60 feet (usually the fifth floor for residential construction), and should be used above 75 feet.
- 11 Along Oxford Street, consider ways to link downtown to the University campus, such as with usable open space, public art and other features.
- 12 For buildings over 85 feet in height, prepare an analysis of potential wind impacts. Protect sidewalks and public open spaces by deflecting downward wind drafts ("wind shear") by using building setbacks, recesses, projections, and other devices (see Figure 40). For projects with potentially significant wind impacts, evaluate massing options with a wind tunnel or other simulation, such as are available at UC Berkeley's College of Environmental Design.
- 13 Consider how the building's form and orientation can take advantage of sun and shade to appropriately heat and cool the building.

Figure 38: Vertical Elements. Consider using continuous vertical features to unify upper and lower floors, while stepping back upper floors.

FRONTAGES, SETBACKS & HEIGHTS (CONTINUED)

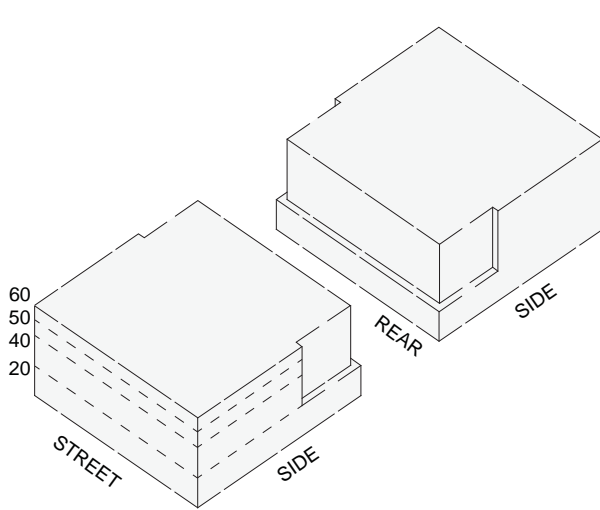

BUFFER DISTRICT

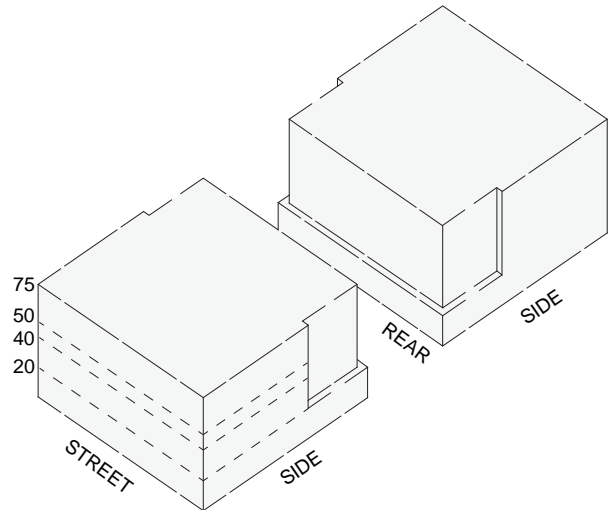

CORE AREA, OUTER CORE AND CORRIDOR AREAS / GENERALLY ALLOWED

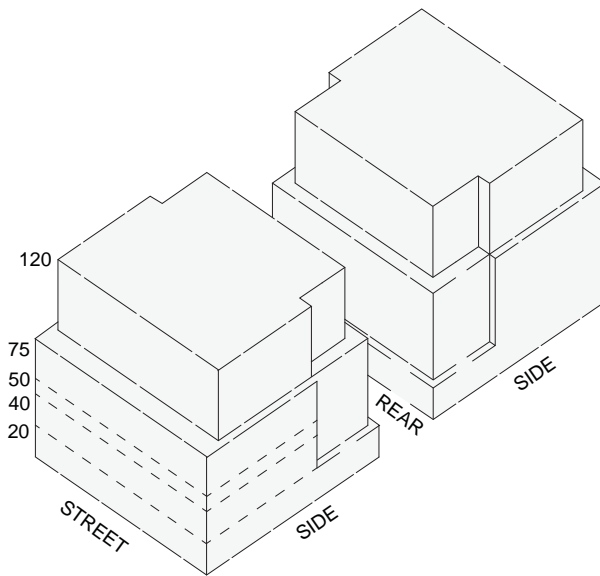

TALLER EXCEPTION UP TO 120', CORE AREA AND OUTER CORE ONLY

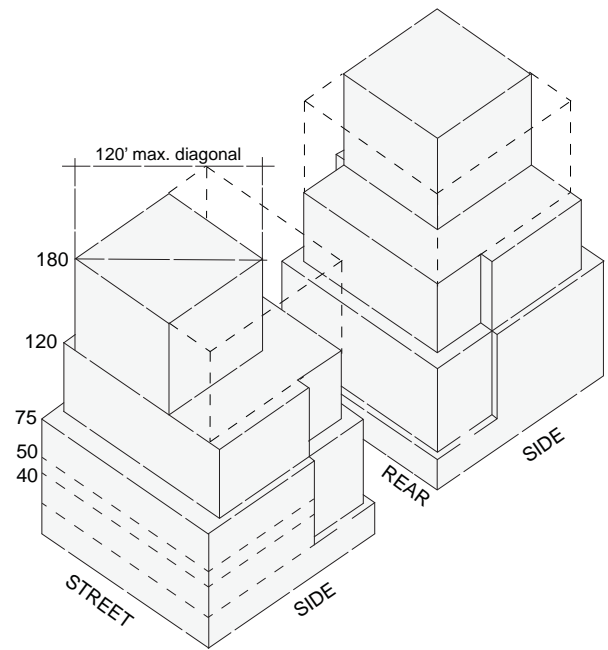

TALLER EXCEPTION UP TO 180', CORE AREA ONLY

Figure 39: Setbacks by Sub-Area.

FRONTAGES, SETBACKS & HEIGHTS (CONTINUED)

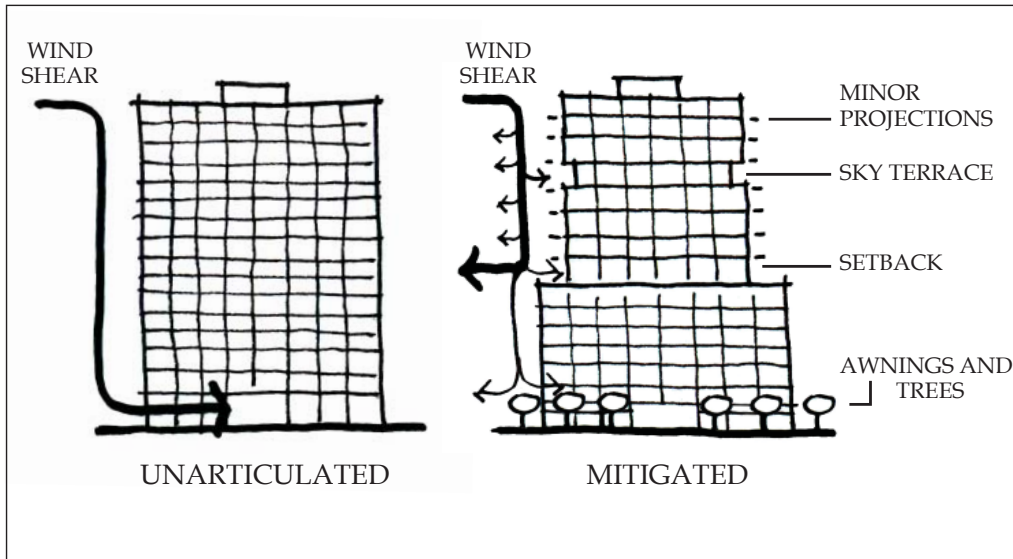

Figure 40: Wind Effects. Consider ways to mitigate potential wind shear impacts from taller buildings by using upper story setbacks, architectural projections and recesses, and trees.

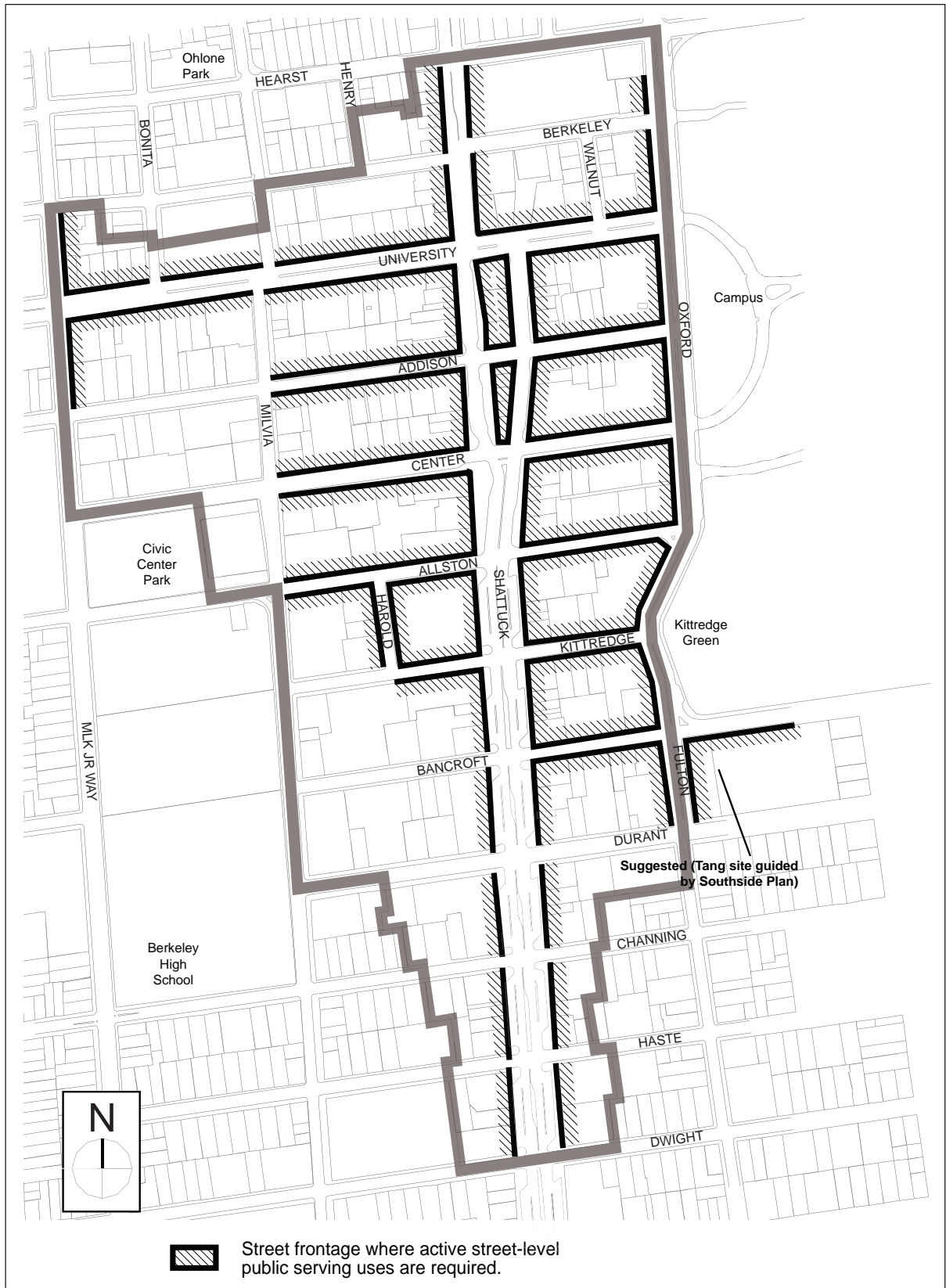

Figure 41: The historic 3-5 story streetwall at the property line should be maintained along Shattuck Ave. to reinforce its urban character and sense of enclosure.



Figure 42: The continuous zero setback and 15-30' rhythm maintains continuous visual interest for the pedestrian.

Figure 43: Public-Serving Frontages



FRONTAGES, SETBACKS & HEIGHTS (CONTINUED)

PUBLIC SERVING FRONTAGES

In addition, along Public Serving Frontages, the following are required (see Figure 43 and Downtown Area Plan, Figure LU-3 “Public Serving Frontage Required”):

- 1 At least one publicly-accessible street-level entrance shall be provided for every 40 feet along a street-facing property line. Any remainder exceeding 30 feet shall also have a publicly-accessible street-level entrance. No two entrances shall be separated by more than 50 feet.
- 2 Clear glass shall comprise at least 60% of the street-facing façade where it is between 3 feet and 8 feet above elevation of adjacent sidewalk.
- 3 The design of the ground floor space shall be visually open to pedestrians such that the design should enable the main activities of the proposed use to be carried out towards the front of the space.

REQUIRED FOR ALL FRONTAGES

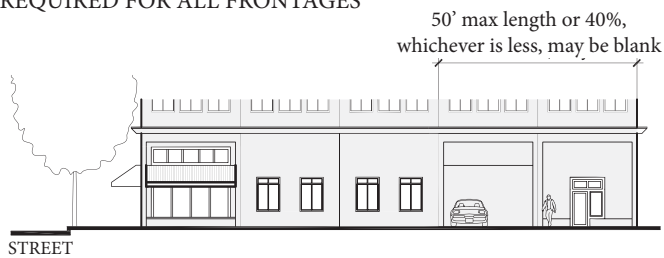

REQUIRED FOR PUBLIC-SERVING FRONTAGES

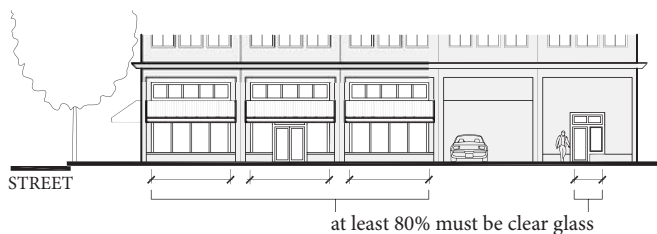

DOES NOT CONFORM

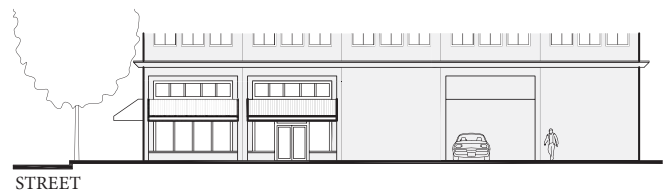

Figure 44: Examples for All Frontages and Public Serving Frontages

HEIGHTS

It is a specific goal of the Downtown Area Plan to provide continuity between the old and new in the built environment, and to respect the unique and historic character of Downtown, while promoting beneficial new development. New development should be scaled down at the periphery of Downtown in order to provide a graceful transitions between Downtown and adjacent neighborhoods.

ALL BUILDINGS

- 1 Consult the Berkeley's Zoning Ordinance for specific height limits for sub-areas within the Downtown.
- 2 Respect the height of neighboring buildings, and provide a sense of continuity and enclosure which avoids abrupt changes in height.
- 3 On the corner sites, locate the tallest elements at the corners, particularly at major intersections, except where ridgeline views may be obstructed.
- 4 New buildings should step down to respect the height of existing residential buildings where they are on parcels with a residential zoning designation.
- 5 New buildings should be setback and have yards similar to adjacent and confronting parcels having a residential zoning designation.

LANDMARK & SIGNIFICANT BUILDINGS

- LS1 Use sensitivity when adding height to historic buildings, and propose additional height only when necessary. Utilize setbacks to minimize the contrast between the old and new. Design with respect for the scale, massing, proportions, and historic character of the building.
- *When relevant, the previous guidelines for All Buildings also apply.*

OPEN SPACES

Inviting open spaces should be provided throughout the Downtown. These spaces should be suitable scaled to their surroundings, and sited in locations which reinforce rather than disrupt pedestrian flow. The most successful open spaces are those which are strongly defined by building forms and/or landscaping, and designed to encourage public use. Encourage open space where it provides a visual connection to the Berkeley Hills and San Francisco Bay.

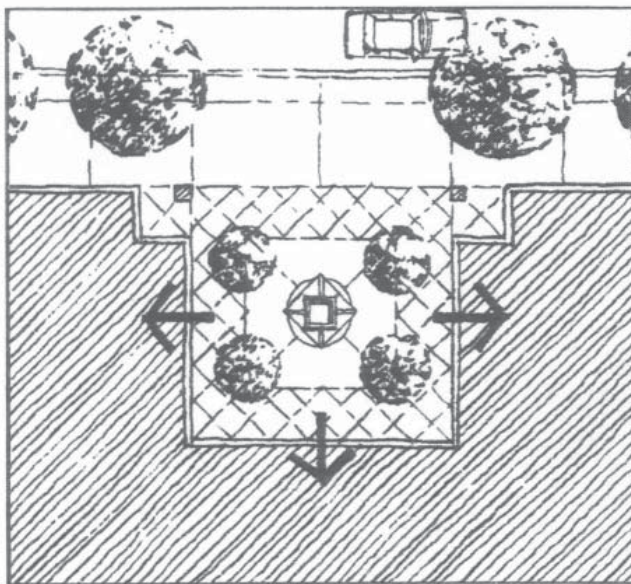
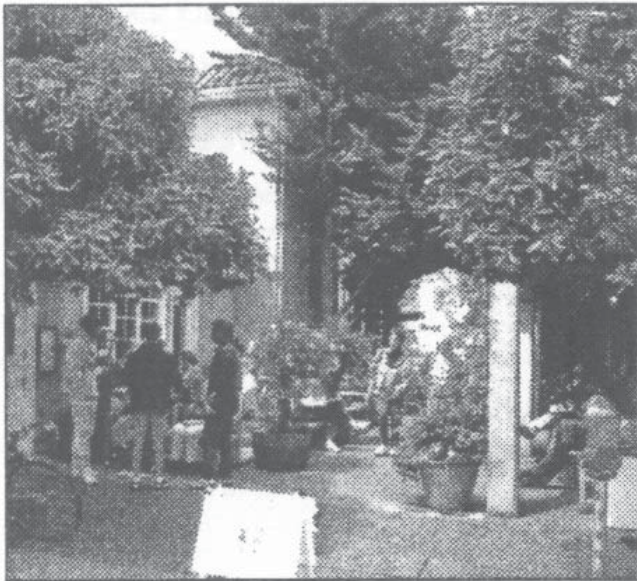

Figure 45: The most successful urban open spaces are enframed and defined by active buildings. The above photo shows a view into such a space, similar to that shown in the diagram.

ALL BUILDINGS

- 1 Preserve views of the hills and bay from Downtown.
- 2 Retain open spaces presently enjoyed by the public. Provide pedestrian amenities that are available to the public, such as plazas, midblock passages, lobbies with seating, and courtyards – while also maintaining Downtown’s general pattern of “streetwalls” – building fronts built close to the street right-of-way) (see Figure 46).
- 3 Community space for the shared use of residents should also be provided and may include courtyards and terraces. Accompany open spaces with landscaping; ample comfortable seating; accent paving; trash receptacles; pedestrian-scale lights; and art. Community room also serve as important “open space.”
- 4 Keep open spaces clean, safe, and well maintained.
- 5 Provide new open space which are deliberately planned, designed, and located to be usable. Street-facing plazas and other publicly-accessible open spaces should have an elevation within a few feet of the abutting sidewalk. Elevation changes of more than a few feet should be avoided (see Figure 49).
- 6 Relate the size, volume, and design of open spaces to the scale of surrounding buildings and streets, and to the numbers of people and types of activities which are encouraged there. Locate new open space to take advantage of natural sunlight where possible.
- 7 Configure new buildings so they enframe and define open spaces, and so building inhabitants face and observe the open spaces.

OPEN SPACES (CONTINUED)

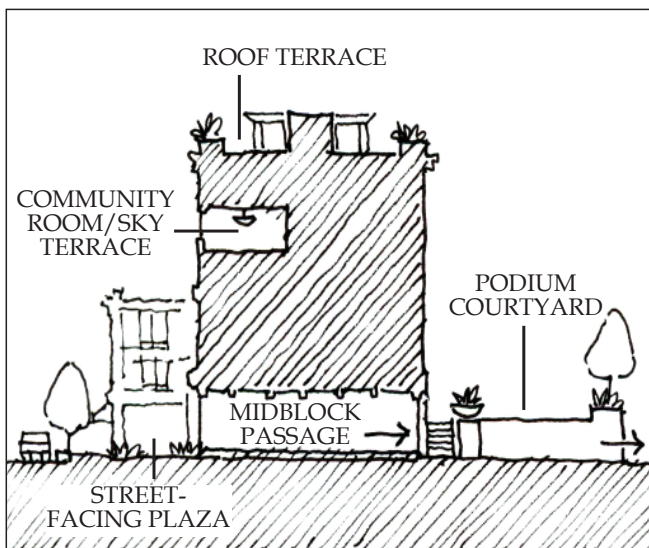

Figure 46: On-site Open Space. On-site open space can take many forms. Publicly-accessible open space may include: street-facing plazas, midblock courtyards, and midblock passages (where opportunities exist). Shared open space for residents may include: podium (raised) courtyards, community rooms (enclosed), upper-floor “sky” terraces (open), and roof terraces.

- 8 Paving in private spaces should be compatible, though not necessarily the same, in color, texture and pattern with paving in adjacent public spaces.
- 9 Provide mid-block passageways where possible to shorten walking distances for pedestrians.
- 10 Use drought-tolerant plants that require little or no irrigation, and avoid plants that require pesticides or high levels of maintenance, such as is recommended in the “Bay-Friendly Basics Landscape Checklist” (www.BayFriendly.org). Consider using landscaping to cool open spaces and building air intake manifolds.
- 11 Consider ways to re-use rainwater for landscape irrigation, or cooling fountains or “water walls.” Retain rainwater to promote infiltration and slow site run-off. A few inches of rainwater might be made visible above retention basins to make attractive “rain gardens” when combined with landscaping or rockery (see Figure 47).

- 12 Green roofs top buildings with soil (or some other growing medium) and vegetation, which are supported over a waterproofing membrane and drainage system. Green roofs insulate, reduce roof replacement and maintenance, retain rain water, and lower urban air temperatures. Encourage green roofs, especially green roofs that can also be used as outdoor amenities by building residents and employees, such as by creating lawns and/or ornamental gardens.
- 13 Work with the City in considering the relationship to and design of abutting sidewalks and other public open spaces. Provide art and/or outdoor seating as part of buildings or public open space where appropriate.
- 14 Preserve historic resources and promote architecture that re-uses all or part of existing buildings that are not historic. Where re-use of non-historic buildings does not occur, consider ways to salvage and re-use materials for plazas and features that contribute to a local sense of place (see Figure 24).



Figure 47: “Rain Gardens”. On-site rainwater retention features can be attractive landscape elements, such as the “rain garden” shown. Rain gardens hold most water below landscaping or rockery but can also fill with a few inches of visible water above during heavy rains.

OPEN SPACES (CONTINUED)

SPECIAL SITES

S1 Preserve the open space at Civic Center Park. Improve its design and maintenance to encourage higher utilization.

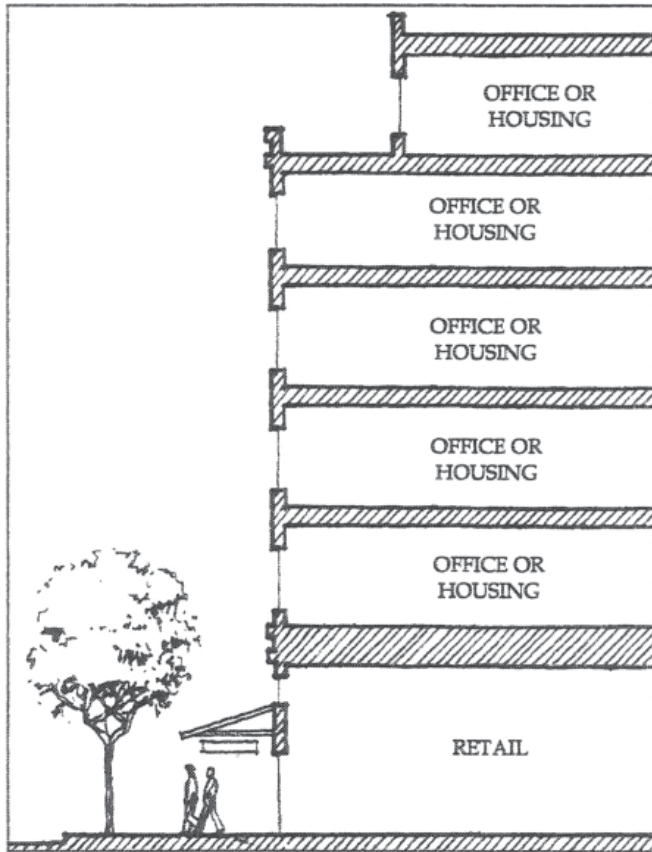

Figure 48: Upper floor setbacks, as shown in this cross-section may be desirable in certain locations to reduce perceived scale, reduce shadow impacts, or preserve views.



APPROPRIATE



APPROPRIATE



NOT APPROPRIATE

Figure 49: Plaza Elevation. Plazas should not be more than a few feet higher or lower than the sidewalk it abuts. Provide clear sight lines into plazas.

PARKING & LOADING

Downtown is first and foremost a place for pedestrians, and every effort should be taken to ensure their comfort, safety and continued patronage. Often, vehicular activity is at odds with this goal. Pedestrians should be given first considerations in site planning for parking and loading.

ALL BUILDINGS

- 1 Give first consideration to pedestrian during the site planning process.
 - 2 For on-site loading and on-site parking, mitigate impacts on the pedestrian to the extent possible. Minimize the impact of curb cuts on pedestrians, such as by utilizing a single curb cut and consolidate vehicular entrances.
 - 3 Locate and design loading areas to minimize their visibility from public spaces, use walls and landscaping to screen views of loading areas.
 - 4 Driveway curb cuts on Shattuck or University Avenues should be avoided.
 - 5 Reduce excessive driveway width where possible, in order to recapture that space for pedestrians instead of vehicles.
 - 6 Locate parking behind buildings, underground, or behind groundfloor storefronts.
 - 7 Locate loading on site, where it does not interfere with pedestrian or vehicular movements.
- *See also Special Sites, Buildings & Subareas.*

SPECIAL SITES, BUILDINGS & SUBAREAS

All other sections of these guidelines also apply. For Landmark Buildings, certain of these guidelines may be superseded by the guidelines in the individual sections for Landmark Buildings.

- CORNER SITES
- IMPORTANT VISTAS
- CIVIC BUILDINGS
- PARKING STRUCTURES
- PARKING LOTS
- SUBAREAS WHERE HISTORIC RESOURCES ARE CONCENTRATED

SPECIAL SITES, BUILDINGS & SUBAREAS

Throughout the Downtown, there are certain building types and areas which should be given particular consideration. Special sites should take advantage of desirable views or characteristics and express good urban design principles. Unique building types such as parking structures and civic buildings should express their function in a way that is harmonious with the pedestrian environment and historic character of Downtown.

CORNER SITES

- 1 Accentuate the corner as the focal point of the site (see Figure 50). This may be accomplished by building to the maximum height, utilizing setbacks, providing definition at the streetwall with landscaping or architectural elements, or providing open space or main entries at the corner.
- 2 At Oxford Street intersections, utilize corner ground and upper floor setbacks to preserve views of the hills from Downtown. [See also Site Design: Frontages & Setbacks]
- 3 Both street fronts are individual facades. (See also Building Design: Facades.)



Figure 50: On corner sites, the corner should be emphasized as a focal point. This building combines a chamfered corner with a more elaborate architectural treatment.

IMPORTANT VISTAS

- 1 Preserve important vistas within the downtown area. Important vistas include: University Avenue in both directions; streets with views of the hills to the east; the west termination of Center Street; the east and west termination of Kittredge Street; the east termination of Allston Way, the north and south termination of Harold Way, the portion of Shattuck Avenue which terminates at University Avenue, and the northwest and southeast corners where Milvia Street jogs at University Avenue.
- 2 On sites which terminate important vistas, design alternations and new construction to communicate the importance of the site, particularly in the loca-



Figure 51: Corner storefronts should 'wrap' the corner to acknowledge the visibility of both frontages from the intersection.

SPECIAL SITES, BUILDINGS & SUBAREAS (CONTINUED)

tion and articulation of entries, overall massing, quality of materials and roof form.

- 3 In particular locations along Shattuck and University Avenues, provide a sense of entry by differentiating the site as a gateway to the Downtown. Incorporate design features that make a strong entrance statement, such as accentuated corners; dramatic façade materials; changes in plane or texture which add depth to facades; overhangs above the right of way; clock towers; special signs or banners; special lighting, paving or landscaping.

CIVIC BUILDINGS

- 1 New civic architecture should have a stately presence, should communicate a sense of permanence and stability for the community, and should be inviting to the public (see Figure 52).
- 2 Locate new civic buildings near public transit, on prominent sites, or as part of the Civic Center.

- 3 Utilize forecourts, lawns or other architectural and landscape devices, in order to identify civic buildings as important sites. Civic buildings may be set-back, unlike other buildings which should maintain a continuous streetwall.
- 4 New construction in the Civic Center area must maintain the cultural character and scale of the area with compatible massing, proportions, and materials. Respect the sense of enclosure surrounding Civic Center Park.
- 5 Around Civic Center Park, provide consistent landscaping, streetscape amenities, and paving patterns and materials.



Figure 52: The Main Post Office includes many design features which identify it as a civic building: it is set back from the street to provide a public forecourt, and its style and materials convey a sense of substance and permanence. The colonnade in particular is an architectural element which is strongly associated with civic buildings.

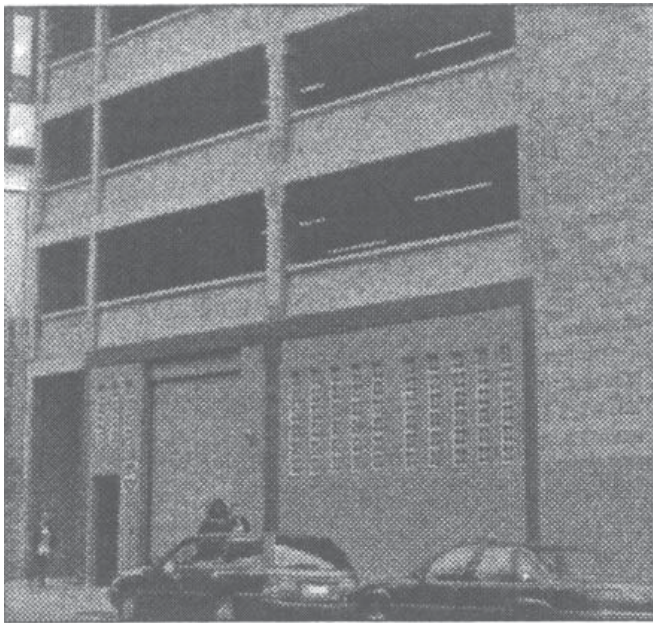

INAPPROPRIATE

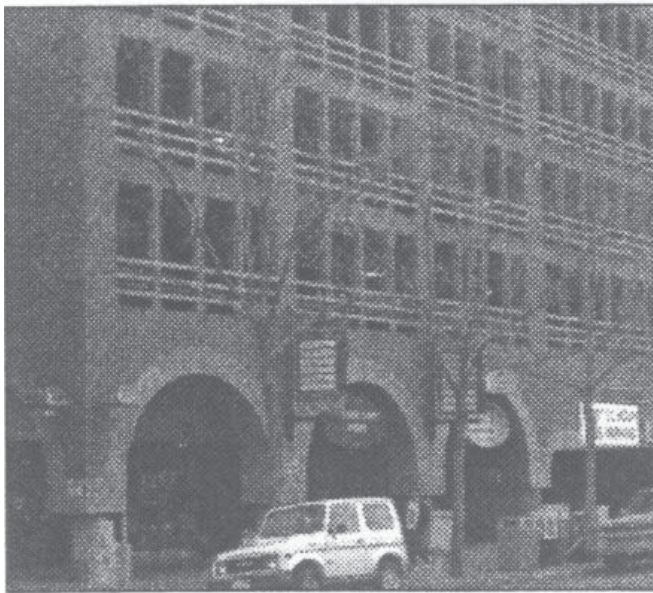

APPROPRIATE

Figure 53: Parking structures should incorporate retail or other active uses on the ground floor, where feasible. The Durant Ave. structure (bottom) does; it also echoes nearby buildings in the pattern of openings on its upper floors.

PARKING STRUCTURES

- 1 Locate parking structures underground or behind buildings where feasible. If not feasible, incorporate retail storefronts and business spaces on the ground floor to maintain the pedestrian character of the downtown. [Refer to Building Design: Storefronts, for guidelines regarding retail storefronts and business spaces.]
 - 2 Design parking structures to be architectural assets, by utilizing appropriate articulation, detailing, massing and scale.
 - 3 For visual and security reasons, avoid solid wall surfaces. Where retail uses are not feasible, break up the massing of large walls. Display cases to exhibit merchandise, artwork or information may be placed in otherwise blank walls.
 - 4 Architecturally distinguish the ground floor from the upper façade, to form a visual base for the building and to be compatible with the historic character of Downtown (see Figure 53).
 - 5 Design upper facades of parking structures in a manner which respects the historic character, proportions, and rhythm of Downtown buildings.
 - 6 Utilize materials, details, and colors which are compatible with neighboring buildings or nearby Landmark and Significant buildings.
 - 7 Design entries so that conflicts between vehicles and pedestrians are minimized. In order to minimize gaps along the sidewalk, entries should be of minimum width. Clearly mark vehicular entries using architectural devices and/or landscaping.
 - 8 Provide illumination that ensures a sense of security for both occupants and passersby. Consider pedestrian routes to and from the parking structures, as well as the garage itself.
- Shield internal lighting to minimize the direct view of lamps from outside the structure. Design rails and parapets to block the view of headlight glare. Refer to the Downtown Area Plan for more information on parking structures.

SPECIAL SITES, BUILDINGS & SUBAREAS (CONTINUED)

PARKING LOTS

- 1 Surface parking lots are not appropriate to Downtown and should be avoided.
 - 2 Where a parking lot cannot be avoided, use low walls or fences, grade separations, plantings, or other devices to screen cars and eliminate gaps in the streetwall caused by surface parking. Don't create a security problem, nor obscure visibility to or from the sidewalk.
 - 3 Perimeter landscaping with trees and shrubs is required. In addition, parking lot trees must be selected and planted to achieve a canopy coverage of at least 50% within seven years. Provide automatic irrigation for all parking lot landscaping.
 - 4 Pave surface parking lots with asphalt, concrete or similar dust-free materials.
 - 5 Circulation must be designed so that all maneuvering will take place entirely within the property line of the lot.
 - 6 Clearly mark vehicular entries to surface parking lots, and design entries so that conflicts between vehicles and pedestrians are minimized. In order to minimize gaps along the sidewalk, entries should be of minimum number and width.
 - 7 Provide illumination that ensures a sense of security for both occupants and passersby. Lighting should be integral to the design of the parking lot, and should be shielded as to avoid direct glare into adjacent uses.
- *Refer to the Downtown Area Plan for more information on parking lots.*



Figure 54: Historic structures on University Ave.

SUBAREAS WHERE HISTORIC RESOURCES ARE CONCENTRATED

Downtown contains subareas with noticeable concentrations of historic buildings - and the potential for cultivating distinct and memorable places. The Downtown Design Guidelines seek to protect and reinforce the overall character of these subareas. In subareas where historic resources are concentrated, designers should pay special attention to a project's context, including the character of adjacent properties and subarea as a whole.

COMPATIBILITY

Within subareas where historic resources are concentrated, building alterations, new construction and public improvements should be designed with particular concern for compatibility with their surroundings, while recognizing the need for continued growth and increased building densities in Downtown's mixed-use areas.

Design new construction and alterations to resonate with prevalent architectural characteristics of historic development in the vicinity of the project including but not limited to: materials, color, cornice, fenestration patterns, structural bays, roof form, vertical projections, overhanging elements, and motif. New features should not precisely replicate but should generally reinforce patterns associated with historic development.

Build consistently with the existing streetwall, particularly at corner sites. Continue dominant rhythms for structural bays and other vertical elements, and for dominant cornice lines, such as between ground floors and upper stories and at the top of facades that meet a street. Set back upper floors so that dominant roof and cornice lines remain generally consistent as seen from the street.

Substantial building renovations should be accompanied by façade improvements that reinforce a subarea's historic character. Where prior alterations that have led to the loss of features that once reinforced the historic character of a subarea, restore such features based on historical evidence.

EXTENT & CHARACTER OF SUBAREAS

The Downtown Area Plan recognizes that a subarea with a concentration of historic resources runs along Shattuck Avenue from about University to Durant, as well as some side streets. The Landmarks Preservation Commission (LPC) should evaluate this and other possible subareas to better understand their defining characteristics and their precise extent. To provide explicit guidance for specific subareas, amend these Guidelines after the character and extent of historic subareas are better understood - and consistent with the possibility that such subareas may be designated as historic districts.

Refer to the Downtown Area Plan Draft Environmental Impact Report (DEIR) for additional discussion on "character-defining features" in the Downtown Area. Use criteria pertaining to historic district designations in Berkeley's Landmark Preservation Ordinance (LPO) and applicable guidelines in the National Register Bulletin "How to Apply the National Register Criteria for Evaluation."

SPECIAL CONSIDERATIONS

All sections of this chapter are interrelated; refer to all of these sections and other chapters as appropriate.

- CODE CONSIDERATIONS
- SEISMIC CONSIDERATIONS
- ACCESSIBILITY
- FUNDING
- SUSTAINABILITY
- STREET & OPEN SPACE IMPROVEMENTS

SPECIAL CONSIDERATIONS

Design decisions are not the only factors which influence the appearance of Downtown buildings. Codes and regulations have tremendous impact on the design of buildings and sites. In today's economic climate, financial considerations are perhaps the most influential determinants of physical form. Special consideration must be given to regulatory, environmental, and financial requirements and incentives in order to produce optimal design solutions which also satisfy functional and physical needs. Of note are programs and regulations to encourage the restoration of and change of use within historic structures.

CODE CONSIDERATIONS

- In addition to these Guidelines, there are city, state, and federal regulations which must be met prior to obtaining a permit for construction. See "Obtaining Permits and Obtaining Planning Approvals" (available at the Berkeley Permit Service Center) for further information.
- Projects involving buildings, properties and features designated as Landmarks, Structures of Merit, and Significant buildings. In addition, buildings evaluated as potentially eligible for listing as historic on the *State Historic Resources Inventory* (SHRI), may utilize the *State Historical Building Code* (Title 24, Part 8). The SHBC allows alternative building regulations for the rehabilitation, preservation, restoration or relocation of historic structures.
- Landmark, Structures of Merit, and Significant buildings, buildings evaluated as historic on the State Historic Resources Inventory (SHRI), and buildings which qualify for the State Register are exempt from California Energy Requirements Exemption 1 to Section 100 (a): Qualified historical buildings as defined in the State Historical Building Code (Title 24, Part 8).

SEISMIC CONSIDERATIONS

- When designing for seismic strengthening, utilize methods which allow for large storefront openings, such as moment frame system rather than shear wall system that can block or cause removal of storefront display windows.
- When designing for seismic strengthening of Landmarks, Structures of Merit, and Significant buildings, utilize methods which are concealed, and which do not damage the historic character of the exterior or interior. When this is not feasible (such as when exterior bracing must be used), restore or replicate damaged areas, and be sensitive to the historic details, spaces, and character of the building. For advice contact the California Main Street Program at 707-631-5029.
- *The Commercial Owner's Guide to Earthquake Safety is available from the Seismic Safety Commission at http://www.seismic.ca.gov/pub/CSSC_2006-02_COG_reduced.pdf or 916-263-5506.*

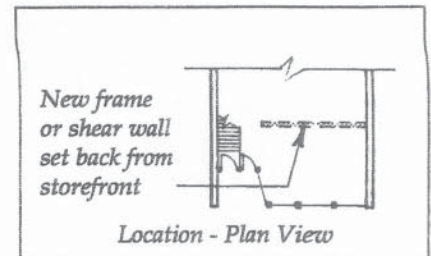
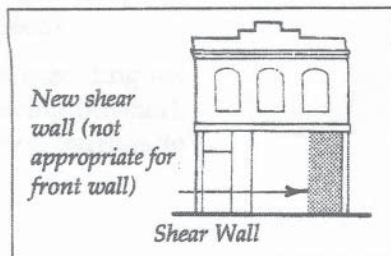
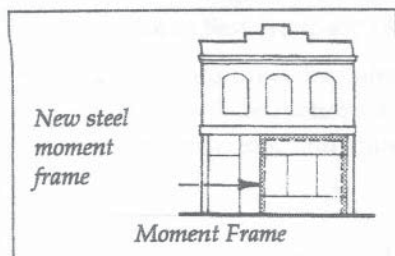

Figure 55: Seismic considerations in historic building retrofits.

Source: California

SPECIAL CONSIDERATIONS (CONTINUED)

ACCESSIBILITY

- *The Americans with Disabilities Act (ADA)*, a civil rights law rather than a building code. It requires that all buildings in which commerce takes place – which includes not only commercial and community uses but also residential rentals – must be accessible to the disabled. When historic properties are altered to meet ADA, modifications should not be done in a manner that would threaten or destroy the significance of the property. The State Historic Preservation Officer should be consulted to determine whether alternative accessibility provisions may be used and what form they may take. The State Office of Historic Preservation (OHP) may be reached at ohp.parks.ca.gov or 916-445-7000.
- When new features are incorporated for accessibility, historic materials and features should be retained whenever possible.
- Two publications provide valuable advice on how to address accessibility to historic buildings. *Preservation Brief #32: Making Historic Properties Accessible, and Preserving the Past and Making it Accessible for People with Disabilities*, are available from the OHP and the National Park Service at <http://www.nps.gov/hps/freepubs.htm>.
- Refer to Funding for information regarding tax credits and deductions for removing physical, communication, and transportation barriers to access.

FUNDING

- Under Section 44 of the Internal Revenue Code, businesses with fewer than 30 employees or gross receipts of less than \$1 million may take a tax credit equal to 50% of the amount of qualified expenditures between \$250 and \$10,250 for making modifications which meet the *ADA Accessibility Guidelines (ADAAG)*. The Section 44 tax credit may be taken in more than one taxable year, but expenses may not be deducted under any other IRS Code tax credit provision.

Also, Section 190 of the IRS Code permits businesses, private entities, and places of public ac-

commodation which are not eligible for the Section 44 tax credit to deduct up to \$15,000 for removing qualified architectural barriers which comply with ADAAG. Examples of eligible access expenditures include the necessary and reasonable costs of removing architectural, physical, communications, and transportation barriers; providing readers, interpreters, and other auxiliary aids; and acquiring or modifying equipment or devices.

More specific information may be obtained from the Architectural and Transportation Barriers Compliance Board, at (800) USA-ABLE, or the Pacific Disability and Business Technical Assistance Center in Oakland at 465-7884.

- The City of Berkeley provides property tax reductions related to Mills Act contracts. There may also be assistance for preservation projects via loans or grants from The California Heritage Fund and the National Trust for Historic Preservation. Federal incentives include 10% and 20% Investments Tax Credits for historic buildings or properties listed or eligible for listing in the National Register. Circumstances vary as to the availability of funding for Downtown projects; contact the City's Office of Economic Development (ecodev@cityofberkeley.info /981-7530), the State Office of Historic Preservation (contact information above) for up to date information. Funding resources are also described in free publications from the National Park Service at <http://www.nps.gov/hps/freepubs.htm>.
- Projects involving National Register or National Register eligible buildings which utilize federal funds are subject to Section 106 of the National Historic Preservation Act. This process requires review of the project by the State Historic Preservation Officer on behalf of the Advisory Council on Historic Preservation. *The Secretary of the Interior's Standards for Historic Preservation Projects* are used as guidance for determining the impact of federally funded projects on historic properties on or eligible for listing on the National Register of Historic Places.
- The *Secretary of the Interior's Standards for Rehabilitation* must be met when the 20% Federal Investment Tax Credit is utilized for projects which involve buildings on or eligible for listing on the Nation-

SPECIAL CONSIDERATIONS (CONTINUED)

al Register of Historic Places. (This may include Berkeley's Landmark and Significant buildings, and buildings evaluated as historic on the State Historic Resources Inventory).

SUSTAINABILITY

- The conservation of older buildings will play an important role in helping the City meet goals contained within its Climate Action Plan. The conservation and reuse of buildings avoids the use of energy and other resources "embedded" within new construction materials – and the greenhouse gases associated with the creation of such materials.
- For all buildings, existing and new, there are numerous ways to enhance the building's environmental performance as it relates to the use of energy and other resources, as are called for in City policy and regulation. As has is discussed in these Design Guidelines, many aspects of "green building" design effect – and can give form to – the appearance of buildings, such as construction type, building form, building orientation, materials, and landscaping.

STREET & OPEN SPACE IMPROVEMENTS

- Berkeley's Downtown Street & Open Space Improvement Plan (SOSIP) addresses the character and performance of Downtown's public realm. The SOSIP should be referred to during the design and review of proposed projects to place project proposals into proper context. Of special note is Policy 6.3 that states: "The aesthetic character of street elements should establish a consistent appearance and reinforce Downtown's historic character, with exceptions made where appropriate. Street elements should have a traditional appearance, . . . [while e]xceptions may be made to showcase public art and features that promote environmental sustainability. Street elements should have a consistent and traditional appearance, and be similar in style as the early 20th-century look of many existing light poles."



Figure 56: Historic structures on University Ave.

